

PREPARED FOR:  
City of Sierra Madre



# The Meadows *at Bailey Canyon* SPECIFIC PLAN

Final Draft  
August 2022







# Table of Contents

## Section

<b>1 INTRODUCTION</b>	<b>1</b>	<b>5 DESIGN STANDARDS AND GUIDELINES</b>	<b>69</b>
1.1 Intent and Purpose of Specific Plan	1	5.1 Purpose and Intent	69
1.2 Organization of the Specific Plan	3	5.2 Relationship to Development Standards	69
1.3 Project Location and Setting	3	5.3 Use of Diagrams and Photographs	69
1.4 Project Description	4	5.4 Site Planning and Design	70
1.5 Authority	6	5.5 Architectural Design	71
1.6 Relationship to the General Plan, Municipal Code and Other Laws	10	5.6 Landscape Design	77
1.7 Community Engagement	12	5.7 Sustainability	78
<b>2 VISION STATEMENT</b>	<b>13</b>	<b>6 IMPLEMENTATION</b>	<b>79</b>
2.1 Introduction	13	6.1 Introduction	79
2.2 Vision Statement	13	6.2 Implementation Procedures	79
2.3 Guiding Principles	13	6.3 Relationship with the City's Municipal Code	80
<b>3 LAND USE, PARK, AND MOBILITY PLAN</b>	<b>15</b>	6.4 Minor Modifications	81
3.1 Introduction	15	6.5 Specific Plan Amendments	82
3.2 Definitions	15	6.6 Appeals	82
3.3 Land Use Plan	15	6.7 Compliance with Mitigation Monitoring Plan	82
3.4 Mobility Plan	18	6.8 Project Financing	82
3.5 Landscape Plan	26	6.9 Project Phasing	83
3.6 Park Plan	31	6.10 Maintenance	83
3.7 Wall and Fence Plan	33	<b>APPENDICES</b>	
3.8 Development Standards	41	1A General Plan Consistency Analysis	84
<b>4 INFRASTRUCTURE AND PUBLIC SERVICES PLAN</b>	<b>51</b>	1B Workshop #1 Summary	102
4.1 Introduction	51	3A Figure Enlargements	109
4.2 Conceptual Grading Plan	51	3B Offsite Improvement Plan	122
4.3 Drainage/Water Quality	54	3C Conceptual Park Buffer Sections	125
4.4 Water Service	61	4A Fuel Modification by Zone	130
4.5 Wastewater Service	62	4B CalFire Defensible Space and Hardening	135
4.6 Dry Utilities	65	5A Architectural Styles Reference Guide	145
4.7 Public Services	67	5B Architectural Elevations	154

# Table of Contents

## Tables

<b>3-1</b> Specific Plan Summary	18
<b>3-2</b> Site Development Standards Matrix (RL Zone)	44
<b>3-3</b> Unit Mix Requirements	46

## Figures

<b>1-1</b> Regional Location	4
<b>1-2</b> Vicinity Map	5
<b>1-3</b> Specific Plan Area	7
<b>1-4a, 1-4b</b> Site Photographs	8, 9
<b>3-1</b> Land Use Plan	17
<b>3-2</b> Specific Plan Mobility Plan	19
<b>3-3</b> Regional Connectivity	21
<b>3-4a</b> Parking Plan	22
<b>3-4b</b> Street Cross Sections	23
<b>3-5</b> Paving and Pedestrian Plan	25
<b>3-6a, 3-6b</b> Conceptual Landscape Plan	27, 28
<b>3-7a, 3-7b</b> Tree and Planting Plan	29, 30
<b>3-8</b> Open Space Plan	32
<b>3-9</b> Conceptual Parks and Recreation Plan	32
<b>3-10a, 3-10b</b> Conceptual Park/Recreation Imagery	34, 35
<b>3-11a</b> Wall and Fence Plan	36
<b>3-11b</b> Wall and Fence Imagery	37
<b>3-12a, 3-12b, 3-12c</b> Street and Wall Sections	38-40
<b>3-13</b> Conceptual Site Plan	50
<b>4-1</b> Existing Topography	52
<b>4-2</b> Graded Topography	53
<b>4-3</b> Conceptual Site Section	54
<b>4-4</b> Regional Drainage	56
<b>4-5</b> Existing Drainage	57
<b>4-6a</b> Proposed Drainage	59
<b>4-6b</b> Proposed Park Detention Basin	60
<b>4-7</b> Existing and Proposed Water System	63
<b>4-8</b> Existing and Proposed Wastewater System	64
<b>4-9</b> Proposed Dry Utilities	66
<b>5-1</b> Attached Garages	70

# 1 Introduction

## 1.1 Intent and Purpose of Specific Plan

The Meadows at Bailey Canyon Specific Plan (Specific Plan) contains the vision statement and guiding principles; land use, park, and mobility plan; infrastructure plan; design guidelines; and an implementation program necessary to achieve the Specific Plan's key objectives through the orderly and compatible development of the Meadows at Bailey Canyon Specific Plan project area (Plan area) located directly south of the Mater Dolorosa Retreat Center (Retreat Center), west of Bailey Canyon Wilderness Park, and north and east of existing single-family neighborhoods, the Specific Plan facilitates the development of single-family homes designed to reflect the character and quality of homes within the greater Sierra Madre community.

The purpose of this Specific Plan is to ensure that the development of the single-family homes and open space areas is designed and constructed consistent with the vision and guiding principles as established in **Chapter 2**, to achieve a new residential community that is distinctly Sierra Madre in quality and character and look and feel. Specifically, the residential community will be designed in a grid pattern typical of Sierra Madre's foothill areas, and will offer a diversity of architectural styles reflecting the variety of architectural styles throughout Sierra Madre which gives Sierra Madre its eclectic charm. Homes and open spaces will utilize durable and sustainable materials

consistent with the character defining features of the architectural styles. The Specific Plan is intended to provide the framework to compatibly develop new homes within the greater, established community, and to aesthetically integrate the homes, public park, and open space areas with the Retreat Center and adjacent residential neighborhoods, and open space.

This Specific Plan is consistent and compatible with the provisions, where applicable, and the goals and policies of the City of Sierra Madre General Plan by enhancing, preserving, and sustaining Sierra Madre's distinctive character and natural resources; ensuring sustainable and harmonious development of high quality and excellent design; and providing safe and welcoming public access and amenities to the community.

The Specific Plan has been prepared in conjunction with a zone change request to change the zoning of the site from Institutional (I) to Specific Plan (SP). The City of Sierra Madre Municipal Code (SMMC), Chapter 17.04, Section 17.04.120, Community Redevelopment Plans—Specific Plans, establishes that any standards relating to land usage shall be determined by the adopted Specific Plan. Therefore, this Specific Plan will serve as the zoning code for the Plan area.

As required by the City of Sierra Madre (City), the following discretionary land use entitlement approvals are necessary to facilitate adoption of the Specific Plan:



- a. **General Plan Amendment and Zone Change.** The property is currently designated and zoned Institutional (I) in both the City's General Plan and Zoning Code. To accommodate the development, a General Plan Land Use Amendment and Zone Change are necessary to revise the General Plan designation and zoning to Specific Plan (SP). The revised land use designation/zone for the property to Specific Plan will provide a mechanism to develop the Plan area consistent and compatible with the surrounding existing uses and to provide public benefits and amenities to the Sierra Madre community.
- b. **The Meadows at Bailey Canyon Specific Plan.** The Meadows at Bailey Canyon Specific Plan's adoption establishes the zoning; vision and guiding principles; land use, park, and mobility plan; development standards and regulations; design guidelines; and implementation provisions governing development within the Plan area.
- c. **Tentative Tract Map (TTM).** A TTM in accordance with Title 16 (Subdivisions) of the SMMC is required for all subdivisions creating five or more parcels. The Meadows at Bailey Canyon Specific Plan creates 42 parcels, each with one unit, for a total of 42 detached residential dwellings, plus private drives, landscape areas, parking, a public park, and open space. In addition, as part of the TTM process, a new legal lot, subject to a conservation easement prohibiting habitable structures from being constructed, will be formed directly north of the Retreat Center, and will be rezoned to the Open Space zone in the City's Zoning Code.
- d. **Lot Line Adjustment (LLA).** The Mater Dolorosa Retreat Center and the Meadows at Bailey Canyon Specific Plan site are on Assessor Parcel Number 5761-002-008. An LLA will subdivide the Retreat Center from the Meadows at Bailey Canyon development.
- e. **Development Agreement (DA).** The DA lays out the obligations of both the City and the developer, including financial and other requirements the developer will be obligated to meet. In addition, the DA will ensure the development of the project area fulfils all requirements of the entitlement approvals and EIR.
- f. **Environmental Impact Report (EIR).** An EIR is being prepared in accordance with the provisions of the California Environment Quality Act (CEQA). The Meadows at Bailey Canyon Specific Plan EIR ensures that potential impacts from the Specific Plan are considered and analyzed and that any mitigation needed to reduce impacts to less than significant are implemented. The preparation and processing of the EIR requires public notification, and encourages stakeholder input and community participation.

## 1.2 Organization of the Specific Plan

The Specific Plan is divided into six chapters. The content of each chapter is described below.

**Chapter 1, Introduction**, describes the intent, purpose, structure, and organization of the Specific Plan. The chapter also describes the Specific Plan location and setting, surrounding land uses, and site characteristics. In addition, the chapter identifies existing conditions, including existing and planned land use designations, that make this Plan area unique. The chapter also discusses the Specific Plan authorization and the relationship between the Specific Plan and the Sierra Madre General Plan, SMMC, and other laws and regulations.

**Chapter 2, Vision Statement and Guiding Principles**, establishes the Vision Statement, which captures the key values and aspirations for future development and establishes the overall vision for the character and design of the Plan area. The second part of this chapter identifies Guiding Principles that flow from and support the Vision Statement.

**Chapter 3, Development Plan and Standards**, identifies the Specific Plan's development plans, including the land use, park, and mobility plan, and development standards to guide the location, character, design, and quality of new development. Each plan is described in detail in this chapter.

**Chapter 4, Infrastructure and Public Services Plan**, describes the infrastructure and utilities needed to serve the Plan area. Specifically, the chapter describes the backbone infrastructure systems (sewer, water, water quality, and storm drainage), utilities (e.g., gas, electricity), roadway design, and public services needed to support the land uses in the Plan area.

**Chapter 5, Design Guidelines**, identifies architectural guidelines, themes, and styles to guide the placement and design of new development, including site planning and design, architectural design, landscaping, accessory structures, and sustainability.

**Chapter 6, Implementation**, describes the Specific Plan implementation procedures that need to be carried out for the Specific Plan vision to be realized.

## 1.3 Project Location and Setting

The Meadows at Bailey Canyon Specific Plan project area is located at 700 North Sunnyside Avenue in Sierra Madre, California. Sierra Madre, located in the County of Los Angeles, is approximately 22 miles northeast of downtown Los Angeles. Located between the City of Pasadena and the City of Arcadia, Sierra Madre is made up of three-square miles of primarily single-family neighborhoods, open space, and green space.

The Plan area is regionally situated at the foothills of the San Gabriel Mountains, less than one mile from the Angeles National Forest boundary to the north. To the west of the Plan area is Pasadena, to the south is Arcadia and Interstate 210 Foothill Freeway, and to the east is the City of Monrovia, as shown by **Figure 1-1, Regional Location**. Locally, the Plan area is accessible via North Sunnyside Avenue, an existing north-south roadway located towards the western boundary of the site. North Sunnyside Avenue will provide primary access to the Plan area. Public access on Carter Avenue, an east-west road, currently ends on the southeast corner of the Plan area; However, the existing gate will be removed, and Carter Avenue will serve as a secondary access point to the Plan area.



Figure 1-1: Regional Map

The Plan area is bounded by Bailey Canyon and Bailey Canyon Wilderness Park to the east, single-family residential neighborhoods to the south and west, and the Mater Dolorosa Passionist Retreat Center to the north. The Retreat Center is primarily used to host religious and silent retreats, days of prayer, fundraising events, and other spiritual programs. The single-family homes surrounding the site are zoned One Family Residential (7,500-square-foot minimum) (R-1), with the exception of homes along the northwest corner of the Plan area, which are within the City of Pasadena and zoned Single-Family Residential (RS-4 HD-1) per the City of Pasadena Zoning Code.

Figure 1-2, **Vicinity Map**, illustrates the Specific Plan vicinity and surrounding development in relation to the Plan area.

## 1.4 Project Description

The Specific Plan allows for the development of approximately 17 acres of undeveloped land that is referred to as “the Meadows” by the Retreat Center. The Meadows at Bailey Canyon development includes 42 detached single-family dwellings on approximately nine acres of the site; public roadways; open space, including an approximately three-acre dedicated neighborhood public park at the southernmost portion of the Plan area; and an approximately one-acre grading



and landscape buffer along the northern Plan area boundary between the Meadows at Bailey Canyon development and the Retreat Center. In addition, the Specific Plan includes the conservation for the City of approximately 35 acres of open space hillside land to the north of the Mater Dolorosa Retreat Center. The approximate 35 acres will include three parcels to be conserved as open space (these three parcels are not considered to be within the Plan area). The parcel directly north of the Retreat Center (shown in orange on **Figure 1-2**), will be subject to a conservation easement prohibiting habitable structures from being built on the parcel, and the lot will be rezoned to Open Space as part of the TTM process. Additional

community benefits will include a net zero water impact, street improvements, underground utilities, and a dedicated funding source for park maintenance.

Given the existing uses surrounding the Plan area shown on **Figure 1-2, Vicinity Map**, the Meadows at Bailey Canyon development is sensitive to and compatible with the ongoing uses of the Retreat Center, existing residential uses, and Bailey Canyon by providing low-density single-family residential development, a public park, and open space that is consistent with the surrounding land uses. The design and layout provide a unique project that is “Sierra Madre Quality,” meaning that by



Figure 1-2: Vicinity Map

its low-density residential development pattern and variety of architectural styles, it retains the small town, eclectic character that is cherished by the community and that are among Sierra Madre's distinguishing features. The public neighborhood park is anticipated to offer outdoor, publicly accessible amenities and natural features. The park will include recreational amenities such as resilient play surfacing, slope slide, play structure and features, seat walls, benches, picnic areas, large turf areas, a small parking lot reserved for accessible parking and loading only, and decomposed granite trail. The park's location and sidewalks along the southern portion of the Plan area provide enhanced pedestrian connectivity to the Bailey Canyon Wilderness Park and the adjacent neighborhoods. The park's location also serves as a buffer to existing homes by providing open space and landscaping, helping to provide compatibility between the existing neighborhoods and the Meadows at Bailey Canyon development.

The Mater Dolorosa Retreat Center and the Plan area are on Assessor Parcel Number 5761-002-008. A Lot Line Adjustment (LLA) and TTM will subdivide the Retreat Center from the Meadows at Bailey Canyon development portion of the parcel. See **Figure 1-3, Specific Plan Area**.

**Figures 1-4a through 1-4b, Site Photographs**, illustrates the existing conditions within the Plan area. The Plan area is currently a shallow, open meadow with various utility easements and a downhill slope generally in the north to south direction.. Existing site elevations range approximately from a low of 1,110 feet above sea level in the southeastern portion of the site to a high of 1,210 feet above sea level in the northwestern

portion of the site. The varying elevations will allow for terraced residential sites to take advantage of views and create naturally occurring diversity across the varying elevations. The Plan area will drain from north to south through two sets of drainage pipes: the ones on the west will flow to the North Sunnyside Avenue existing underground pipe; and the ones on the east will flow from Streets A, B and C east to Carter Avenue and then south to the detention basin in the public park, then off site to existing storm drains at the south end of the property. As further detailed in **Chapter 4**, the retention and stormwater treatment facility located within the public park will be designed to retain and treat all onsite stormwater runoff.

## 1.5 Authority

The Specific Plan has been prepared pursuant to the provisions of the California Government Code, Title 7, Division 1, Chapter 3, Article 8, Sections 65450 through 65457. The California Government Code authorizes jurisdictions to adopt Specific Plans by resolution as policy documents or by ordinance as regulatory documents. The law allows preparation of Specific Plans as may be required for the systematic execution of the General Plan and further allows for their adoption and amendment. Government Code Section 65451 governs content and requires that Specific Plans include text or diagrams which specify the following:

**Land Use:** The specific plan must specify the distribution, location, and extent of land uses, including open space, within the area covered by the plan. This is included in **Chapter 3, Development Plan and Standards**, in this Specific Plan.





Figure 1-3: Specific Plan Area





*Development site looking south.*



*Pathway at the Retreat Center.*



*Sunnyside Ave. looking north.*



*Development site looking northwest on Carter Ave.*

**Figure 1-4a: Site Photographs**





*Sunnyside Ave.*

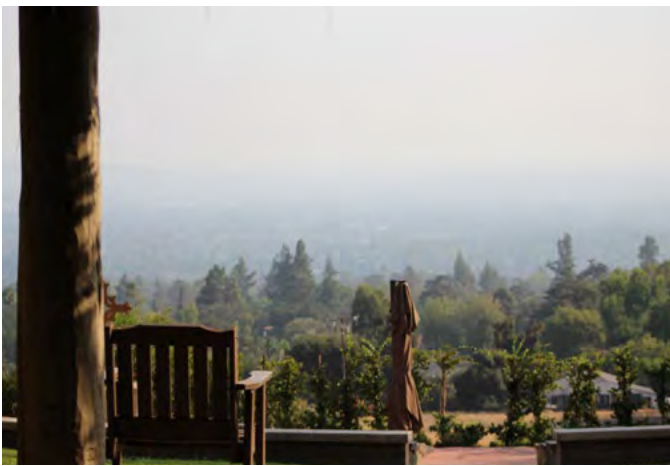

*View from the Retreat Center.*



*View of the southern neighborhoods from the site.*



*Development site looking north.*

**Figure 1-4b: Site Photographs**

**Public Facilities:** The specific plan must show the existing and proposed distribution, location, and extent and intensity of major components of public and private transportation, sewage, water, drainage, solid waste disposal, energy, and other essential facilities located within the area covered by the plan and needed to support the land uses proposed in the plan. This is included in **Chapter 4, Infrastructure and Public Services Plan**, in this Specific Plan.

**Development Standards:** The specific plan must include standards and criteria by which development will proceed, and standards for the conservation, development, and utilization of natural resources, where applicable. This is included in **Chapter 3, Development Plan and Standards**, in this Specific Plan.

**Implementation Measures:** The specific plan must include a program of implementation measures, including regulations, programs, and financing measures. This is included in **Chapter 6, Implementation**, in this Specific Plan.

**General Plan Consistency:** The specific plan must include a statement of the relationship of the specific plan to the General Plan. An analysis of the Specific Plan's consistency with the applicable goals of the City of Sierra Madre General Plan is contained in **Appendix 1A, General Plan Consistency Analysis**, of this Specific Plan.

**Optional Contents:** The specific plan may address any other subject that, in the judgment of the planning agency, is necessary or desirable for implementation of the General Plan. This Specific Plan includes general architectural guidelines, themes and styles, and other applicable architectural guidelines in **Chapter 5, Design Guidelines**.

The Specific Plan is regulatory in nature and will serve as the zoning code for the Specific Plan site. The Specific Plan is prepared in accordance with SMMC, Chapter 17.04, Section 17.04.120, Community redevelopment plans—Specific plans, which establishes that whenever an area of Sierra Madre has been included in an approved redevelopment plan or a Specific Plan adopted pursuant to Section 65000 et seq. of the Government Code, any standards relating to land usage shall be determined by the adopted Specific Plan. Development plans, parcel and/or tract map(s), and other entitlement requests processed in conjunction with or following the adoption of the Specific Plan must be consistent with both the regulations set forth in this Specific Plan and with all other applicable City regulations.

## **1.6 Relationship to the General Plan, Municipal Code and Other Laws**

### **1.6.1 Relationship to the General Plan**

The Specific Plan implements the goals and policies of the City's General Plan. **Appendix 1A, General Plan Consistency Analysis**, contains an analysis of the Specific Plan's consistency with the General Plan. Upon adoption of the Specific Plan, the General Plan land use designation will be changed from Institutional (I) to Specific Plan (SP) (Resolution No. \_\_\_\_\_), in order to provide a mechanism to develop the Plan area consistent and compatible with the surrounding existing uses and to provide public benefits and amenities to the Sierra Madre community.



## **1.6.2 Relationship to the Sierra Madre Municipal Code**

Upon adoption of the Specific Plan, the Zoning for the Plan area will be changed from Institutional (I) to Specific Plan (SP) (Ordinance No. \_\_\_\_\_), and the Specific Plan will be incorporated into the SMMC. The Meadows at Bailey Canyon Specific Plan provides the allowable land uses, zoning and development regulations, design guidelines, and implementation procedures for the property within the boundary of the Specific Plan. The regulations contained within the Specific Plan are in addition to those set forth in the planning, zoning, and subdivision provisions of the SMMC, and do not convey any rights not otherwise granted under the provisions and procedures contained in the SMMC or other ordinances, except as specifically provided for herein. Whenever the Specific Plan contains provisions that establish regulations, including, but not limited to, uses, densities, intensities, and height, floor area, lot area and coverage, setback, parking, open space, and landscaping requirements, which are different from, or more restrictive or permissive than would be allowed pursuant to the provisions of the SMMC, the Specific Plan shall prevail and supersede the applicable provisions of the SMMC.

## **1.6.3 Compliance with Senate Bill (SB) 18 and Assembly Bill (AB) 52**

Pursuant to California Senate Bill (SB) 18 and California Assembly Bill (AB) 52, the City of Sierra Madre provided formal notification of the Meadows at Bailey Canyon Specific Plan to all groups provided by the California Native American Heritage Commission and all groups that have previously requested

formal notification of projects for which Notice of Preparation, Notice of Mitigated Negative Declaration or Notice of Negative Declaration is filed on or after July 1, 2015. (Stats. 2014, ch. 532, § 11 (c)). The purpose of the notification was to provide a description of the project, identify that the project would involve ground disturbance, and request consultation, including any comments or concerns, regarding the project and potential impacts to Tribal Cultural Resources (as defined in Public Resources Code § 21074). The request for consultation per AB 52 and SB 18 was sent on March 30th, 2021, followed by a comment and consultation period including a 30-day consultation period for AB-52 and a 90-day consultation period for SB-18. As of April 9th, 2021, one request for consultation was received from the Gabrieleno Band of Mission Indians --Kizh Nation.

## **1.6.4 Compliance with California Environmental Quality Act**

In accordance with the provisions of CEQA, the Meadows at Bailey Canyon Specific Plan EIR (SCH #2020060534) analyzes and reviews potential impacts from the Specific Plan's implementation, and provides corresponding mitigation measures needed to reduce impacts to less than significant. In accordance with California State law, the Draft EIR was publicly notice and circulated for public review from August 2, 2021 to October 4, 2021, and was certified by the Sierra Madre City Council (Resolution No. \_\_\_\_\_).

## 1.7 Community Engagement

The City of Sierra Madre, in coordination with the Mater Dolorosa Community and MIG, Inc., held three in-person public meetings on August 4, 2020, at the Tennis Courts at Memorial Park in Sierra Madre, as well as one virtual meeting on August 5, 2020, to seek public input on the proposed project. Each workshop was structured with two parts: 1) as an open house during the first 30 minutes to allow attendees to review presentation boards of the proposed subdivision and park; and 2) as a presentation with a question and answer session during the following 90 minutes. During the question and answer session, MIG staff graphically recorded the questions and comments from attendees, as well as responses from City staff and the development team representatives.

Questions from the community related to a variety of topics, including, but not limited to, water conservation and retention; hillside protection; public access; road widths; the size of parcels, homes, and the public park; fire risk mitigation; trail connectivity; lighting; and other impacts. Comments and concerns were also expressed that included a desire to consider broader housing needs, active recreation space such as ball fields, traffic impacts, loss of privacy for North Sunnyside homes, compatibility concerns with the Retreat, the size of homes, and other impacts to the adjacent neighborhood. Twelve (12) comment cards were received from the three meetings. The comments provided a mix of support and opposition to the project. Questions and responses from the community were summarized in a workshop summary and are included in **Appendix 1B, Workshop #1 Summary**, of this Specific Plan.

On Tuesday, March 9th, NUWI Sierra Madre LLC presented the proposed subdivision and park during the City of Sierra Madre's City Council meeting. As part of the City of Sierra Madre's COVID-19 transmission mitigation efforts, the City Council meeting took place at the City of Sierra Madre Memorial Park Bandshell and was streamed on the City's website. The presentation, which included architectural presentations and information boards, addressed Council Member's questions, namely, regarding the Trip Analysis Study Methodology, EIR Sustainability measures, the buffer zone on the west side of the proposed development and addressing privacy concerns. Their questions were followed by comments from the public. Sixteen (16) public comments were noted in the City Council meeting minutes by the City of Sierra Madre. The comments provided a mix of support and opposition to the project. Comments and concerns included an interest from the public to review the project EIR and Specific Plan, as well as a desire to consider broader land uses, fire risk, water and traffic impacts, and the proposed design.

# 2 Vision Statement and Guiding Principles

## 2.1 Introduction

This chapter describes the Vision Statement for the Specific Plan, which captures the key values and aspirations for future development and establishes the overall vision for the design and character in the Plan area. Additionally, this chapter describes a set of Guiding Principles that flow from and support the Vision Statement, and which will help guide the future development of the Plan area.

## 2.2 Vision Statement

The Meadows at Bailey Canyon Specific Plan Area will be a new residential neighborhood that is distinctly Sierra Madre in quality, character, and look and feel. The Specific Plan is intended to provide the framework to aesthetically integrate the homes, public park, and open space areas with the adjoining neighborhoods, Bailey Canyon Wilderness Park and Retreat Center. Designed in a traditional grid pattern reflective of Sierra Madre's foothill areas, the Meadows at Bailey Canyon development will provide 42 new single-family homes in a diversity of architectural styles, reflecting a similar diversity and eclectic charm that is seen throughout Sierra Madre. Sited at the foothills of the San Gabriel Mountains, the Meadows at Bailey Canyon neighborhood will offer views south of the City of Sierra Madre and the San Gabriel Valley, while protecting the privacy of existing adjacent homes and the Retreat Center. Ample setback spacing, landscaping, and open space together act as a protective buffer

between the Meadows at Bailey Canyon neighborhood and existing development on the north, west, and south perimeters of the Plan area. In the southernmost portion of the Plan area, a new public park, with a pedestrian connection to the Bailey Canyon Wilderness Park and trail, will serve as a community amenity to locals and visitors. To the north, the serene grounds of the Mater Dolorosa Retreat Center will remain intact and uncompromised in its ability to function as the spiritual retreat it is known for.

## 2.3 Guiding Principles

To implement the Vision Statement, the following guiding principles provide direction for ongoing decision making, improvements, and development at the Meadows at Bailey Canyon. As the Plan area takes its shape and form, the Meadows at Bailey Canyon will:

- **Be sensitively sited to minimize hillside hazards** while protecting the San Gabriel Mountain Foothills' forest, open space, watershed, and all other natural resources. *For example, development will minimize the amount of grading and removal of natural vegetation.*
- **Be an exemplar of environmental sustainability in both building and site design** to minimize an undue burden on existing City services and infrastructure and the impact on the environment. *For example, development will incorporate various*

water conservation practices, such as, permeable ground surfaces, drought tolerant landscaping, green building materials, rainwater capture devices, and low-flow fixtures.

- **Be harmoniously integrated into the neighborhood** to protect the privacy of adjacent neighbors and stand as a seamless extension of the distinctive small-town character unique to the Sierra Madre community. *For example, development will incorporate the standards and guidelines that are incorporated within the Good Neighbor Plan, which promote compatibility with the immediately adjacent neighbors and existing uses, such as rear balconies facing existing units to the west shall be set back at least 35 feet from the property line.*
- **Reflect and enhance the architectural character and charm that is distinctly Sierra Madre** through a diversity of high-quality architectural design, style, and materiality to stand the test of time and add enduring value to the overall Sierra Madre community. *For example, development will incorporate architectural design details and elements which provide visual character and interest.*
- **Provide public benefits and amenities to the Sierra Madre community** via public access and open space. *For example, the neighborhood will make available a new public park that welcomes locals and visitors, connects to the Bailey Canyon Wilderness Park and trail, and acts as a buffer to the existing adjacent homes.*

- **Provide safe and welcoming public access to the site** from North Sunnyside Avenue and Carter Avenue for motorists and pedestrians while minimizing traffic impacts to adjacent residential streets. *For example, development will enhance the pedestrian character of the City, by providing walkways, pedestrian linkages, and public open activity spaces.*



# 3 Development Plan and Standards

## 3.1 Introduction

This chapter describes in detail the development plans of the Meadows at Bailey Canyon Specific Plan, including the land use, park, and mobility plan, and development standards to guide the location, character, design, and quality of new development within the Plan area. When followed, these standards shall ensure that development within the Meadows at Bailey Canyon neighborhood will complement the character and desirability of the adjacent neighborhood, the Mater Dolorosa Retreat Center, and the greater Sierra Madre community and implement the Vision Statement and Guiding Principles.

If conflicts occur between the standards contained in this Specific Plan and those found in the City of Sierra Madre Municipal Code (SMMC), the development standards in the Meadows at Bailey Canyon Specific Plan shall supersede all provisions, standards, and requirements of the City's Zoning Ordinance.

## 3.2 Definitions

For this title, the words, phrases, and terms set forth in this chapter shall be deemed to have the meaning ascribed to them in this chapter. Terms not defined in this chapter shall have the same definitions provided in the City's Zoning Ordinance, Chapter 17.08, Definitions, as amended from time to time.

**Gross Floor Area** shall have the meaning ascribed in Section 17.20.015, Definitions, of the SMMC, excepting interior areas, regardless of height, shall be counted only once.

**Height.** The vertical distance of the structure measured from natural or pre-existing grade, or finished floor, whichever is higher, around the perimeter of the building to the highest point of the coping of a flat roof or to a point one-third of the height of a pitched or hipped roof.

## 3.3 Land Use Plan

The Specific Plan is designed to deliver a new residential community with a cohesive set of diverse, architectural styles that are intended to compliment the architectural diversity of the existing structures that gives Sierra Madre its eclectic charm. The Specific Plan's Vision Statement and Guiding Principles guide the Land Use Plan.

The approximately 17-acre Plan area provides the opportunity to develop attractive, new homes that complement and enhance the existing charm that is unique to Sierra Madre as a historic small town nestled in the foothills, but within a major metropolitan area. The Meadows at Bailey Canyon development consists of 42 one- and two-story detached single-family dwellings on approximately nine acres of the Plan area. Typical floor areas range in size from approximately 2,700 to 3,775 square feet with a minimum lot size of 7,800 square feet.

On the southern boundary adjacent to an existing -single-family neighborhood, a dedicated public park will serve as a new community amenity on approximately three acres of the Plan area, both unifying the community by providing a community gathering space and providing privacy to the existing neighbors by acting as a landscape buffer between the Meadows at Bailey Canyon homes and the existing adjacent homes to the south. Along the northern boundary, a grading and landscape buffer on approximately one acre of the Plan area will enhance privacy between the Meadows at Bailey Canyon development and the Retreat Center. On the west side of the Meadows at Bailey Canyon development, additional rear yard setbacks and use restrictions for homes will provide enhanced privacy for the existing adjacent homes by providing additional buffering from potential visual intrusions and unit siting.

The neighborhood park is anticipated to offer outdoor, publicly accessible amenities and natural features. The park shall include recreational amenities such as resilient play surfacing, slope slide, play structure and features, seat walls, benches, picnic areas, large turf areas, a small parking lot reserved for accessible parking spaces as required by law and loading only, decomposed granite trail, and water quality treatment and detention basin. Pedestrian access to the Bailey Canyon Wilderness Park and trail will be enhanced through a pedestrian path in the southeast corner of the Plan area.

The Land Use Plan (see **Figure 3-1, Land Use Plan**) and the Specific Plan Summary (see **Table 3-1**) provide the framework for development of the Specific Plan area.

This section establishes the Specific Plan's zones (Residential Low Density [RL] and Open Space [OS]) and its uses and acreage. As defined on **Figure 3-1**, the RL zone, shown in yellow, includes lots 1-42; the OS zone, shown in light green, includes the open space lots B through F, and the park space lot 43 (refer to **Figure 3-8's** legend or see **Section 3.5, Landscape Plan**, for [OS] maintenance responsibilities). The grading and landscape buffer lot A, shown in red hatching on **Figure 3-1**, will be maintained by the Retreat Center upon completion of lot A's walls, gates and landscaping as provided in this Specific Plan.

### 3.3.1 Zoning Designations

The following two zoning designations are established by this Specific Plan and are applied to properties within the Plan area, as shown on **Figure 3-1, Land Use Plan**.

**Residential Low Density (RL).** The RL zone is applied to areas appropriate for a variety of detached single-family residential dwellings, with both parking garages and driveway parking. This zone also allows secondary uses as permitted in Section 3.8.4, Allowed Land Uses/Permit Requirements, of the Meadows at Bailey Canyon Specific Plan.

**Open Space (OS).** The OS zone is applied to areas that provide parks for active or passive recreation or enjoyment, open space, or other natural, physical assets to improve the aesthetic and functional features of the neighborhood. The OS zone is envisioned for open space lots and for the approximately 3-acre neighborhood public park area at the southern portion of the Plan area.



Figure 3-1: Land Use Plan



Zone <sup>1</sup>	Use Type	Other Land Uses	Acres (gross)	Dwelling Units
RL	Detached, Single-Family Dwellings	Private Drives, Landscape Areas, Parking	9.19	42
OS	Public Park, and Landscape Buffer and Open Space	Pedestrian Paths, Natural Features, Landscaping, Play Equipment, Picnic Area and Seating, Restroom Building, Parking	3.36	–
–	Grading and Landscape Buffer	Walls, Gates, and Landscaping	1.07	–
–	Project Roadways	North Sunnyside Avenue, Carter Avenue, and Streets A, B, and C	3.68	–
<b>TOTAL</b>			<b>17.30</b>	<b>42</b>

Notes:

<sup>1</sup> RL = Residential Low Density, OS = Open Space.

**Table 3-1:** Specific Plan Summary

### 3.4 Mobility Plan

The Mobility Plan provides for a private vehicular and pedestrian circulation system of public roadways and sidewalks within the Plan area. The Mobility Plan is designed as an extension of the existing local roadway access to the Plan area. The Mobility Plan provides for streets with parking, parkways, tree plantings, and landscaping.

The Meadows at Bailey Canyon development is designed to be primarily accessed from the improved North Sunnyside Avenue extension and from Carter Avenue as a secondary access route, and provides increased connectivity to nearby uses, including Bailey Canyon Wilderness Park, the Retreat Center, and the greater Sierra Madre community. The Plan area is linked to the existing Sierra Madre community via North Sunnyside Avenue and Carter Avenue. Within the Plan area, the Mobility Plan’s sidewalks connect the community to the public park at the southern area of the Plan area, a key neighborhood feature, enhancing pedestrian safety and mobility. ADA accessible paths of travel and ADA ramp locations are shown on **Figure 3-2, Specific**

**Plan Mobility Plan** (see **Section 3.4.4** for Pedestrian and Paving Plan details). Accessible path of travel and accessible ramps will be designed to meet Public Right of Way Accessibility Guidelines (PROWAG).

The Mobility Plan’s street network is made up of North Sunnyside Avenue and Carter Avenue, which generally run north-south through the Plan area, and Streets A, B, and C, which run east-west. North Sunnyside Avenue will provide primary public access to the Plan area, while Carter Avenue will provide secondary access to the Plan area, including access to the park. The Specific Plan's Mobility Plan is conceptually shown on **Figure 3-2**.

#### 3.4.1 Existing Regional Circulation and Access

Regional access to and from the Plan area is via Michillinda Avenue, the only street considered a major street in the Sierra Madre General Plan Circulation Element. Michillinda Avenue is shared by the cities of Pasadena and Arcadia and provides a connection to Interstate 210. Michillinda Avenue is one block west of the Plan area and can be accessed via

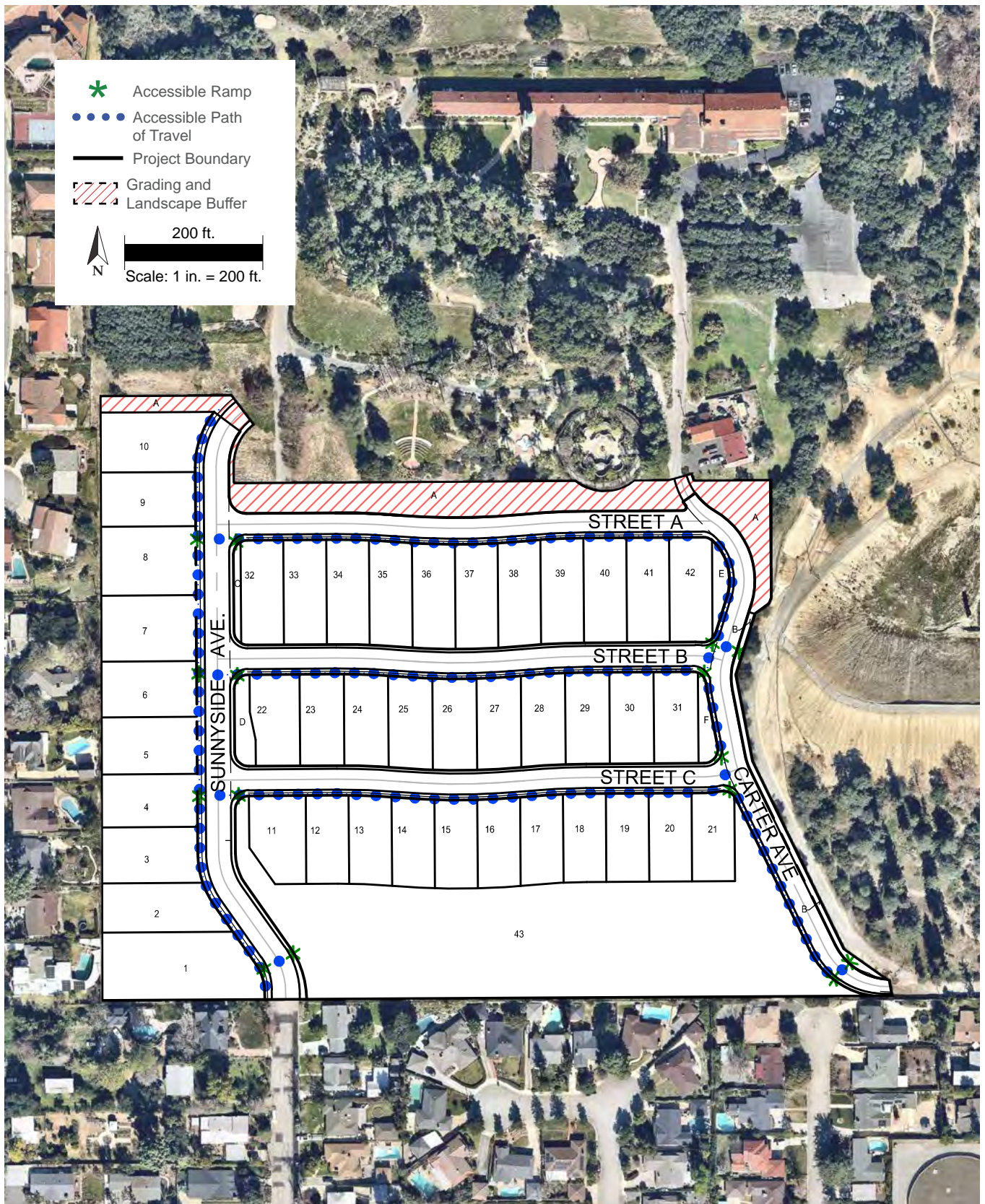

Figure 3-2: Specific Plan Mobility Plan



several local streets off North Sunnyside Avenue. Sierra Madre Boulevard, classified as a collector street in the Sierra Madre General Plan Circulation Element, can also be accessed from North Sunnyside Avenue and provides another direct connection to Pasadena and Arcadia. Regional connectivity to the Plan area is depicted in **Figure 3-3, Regional Connectivity**.

### 3.4.2 Existing Local Roadway Circulation and Access

North Sunnyside Avenue, an existing north-south public roadway, provides primary vehicular access to the Plan area. Public access for the roadway currently ends at the Retreat Center's gate on the southern perimeter of the Plan area. The Retreat Center gate will be removed as part of the Meadows at Bailey Canyon development and relocated to the northern boundary of the Plan area; North Sunnyside Avenue will be extended and improved. North Sunnyside Avenue will transition from a width of 40 feet at its existing terminus to a varying 54- to 56.5-foot right-of-way within the Plan area.

Carter Avenue, an east-west, paved asphalt road with an existing 25-foot right-of-way, currently ends at a gate on the southeast corner of the Plan area. The gate will be removed, and the street will serve as a secondary access route, allowing vehicles to exit and enter from the Plan area to the existing Carter Avenue.

As further discussed in **Section 3.4.3**, off-site improvements will include widening an existing segment of Carter Avenue. The proposed improvements will occur outside of the Plan area between the southeastern boundary of the Plan area and Oak Crest Drive. Within the Plan area, Carter Avenue will have a varying 44.5- to 46-foot right-of-way. Adjacent to Carter Avenue, there is an

existing gated road that provides access for the Los Angeles County Public Works Department to Bailey Canyon. The gate to the Los Angeles County access road is directly adjacent to the existing Carter Avenue gate. Future development within the Specific Plan is encouraged to be coordinated with the County of Los Angeles for the potential to consolidate the access road with the newly improved Carter Avenue within the Plan area and relocate the County access road to the north of its existing entrance.

Refer to **Figure 3-3**, for an overview of regional connectivity and roadways outside of the Plan area.

Based on the Specific Plan EIR's findings, the Meadows at Bailey Canyon development would not result in impacts to transportation. As such, the Mobility Plan is designed to provide an internal circulation system that would facilitate safe and efficient access to the Plan area from North Sunnyside Avenue and Carter Avenue while minimizing traffic impacts to adjacent residential streets.

### 3.4.3 Proposed Streets and Parking

Three east-west local streets (Streets A, B, and C) will connect Sunnyside Avenue to Carter Avenue within the Plan area. A total of 134 on-street parking spaces will be provided within the Plan area along segments of Sunnyside Avenue, Carter Avenue, and Streets A, B, and C as shown on **Figure 3-4a**, Parking Plan. In addition, two proposed ADA-compliant parking spaces will be provided in the park's parking lot, which will be reserved for accessible parking spaces as required by law and loading only (see additional details under **Section 3.6, Park Plan**).



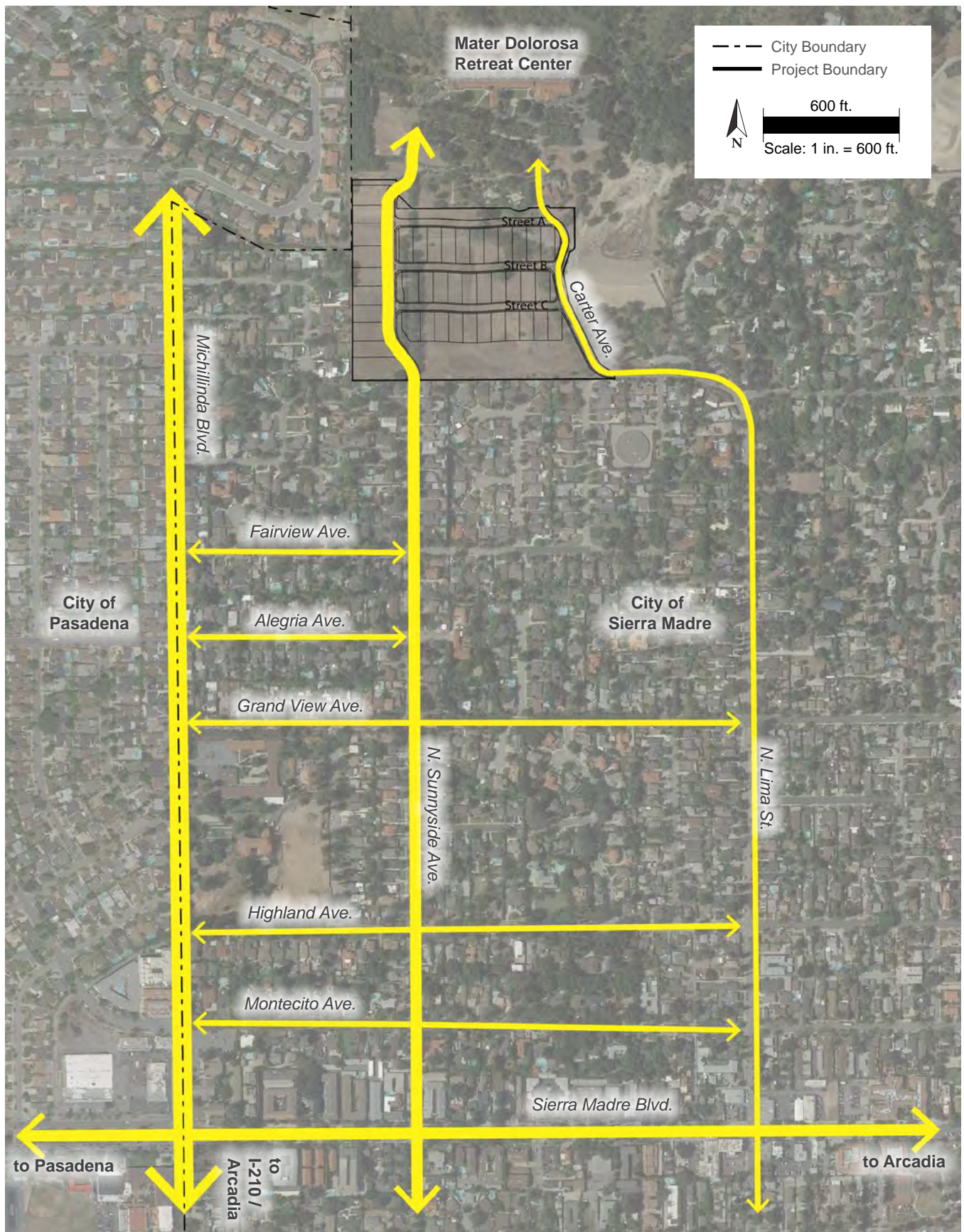
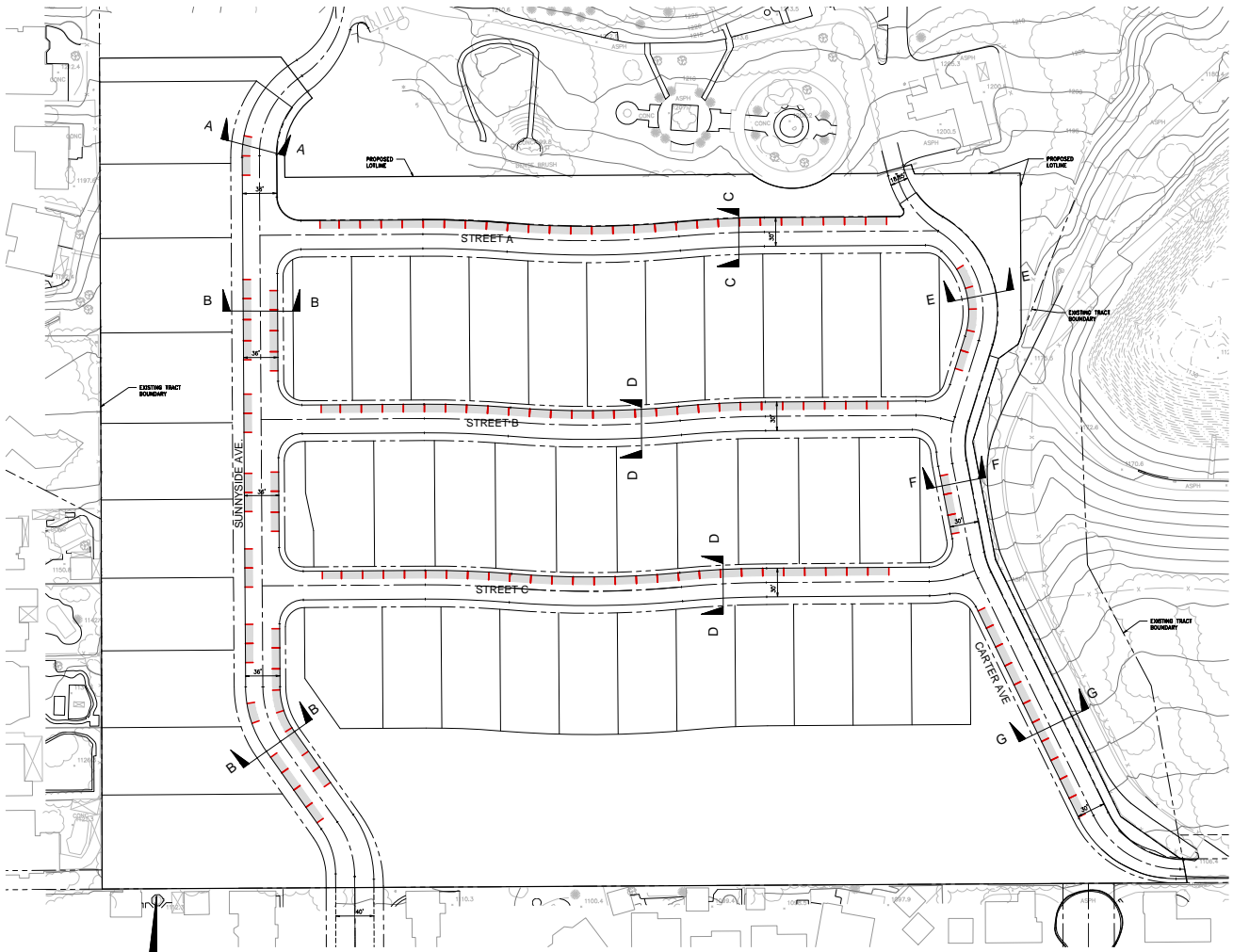



Figure 3-3: Regional Connectivity



Total On-Street Parking Provided in Specific Plan: 134 spaces

Note: 2 additional accessible parking spaces will be provided within the public park.

 On-Street Parking

 Project Boundary

**Parking Details**

Parking Provided Along Sunnyside Avenue, and Streets A, B, and C: 115 spaces

Parking Provided Along Carter Avenue: 19 spaces

**Figure 3-4a: Parking Plan**

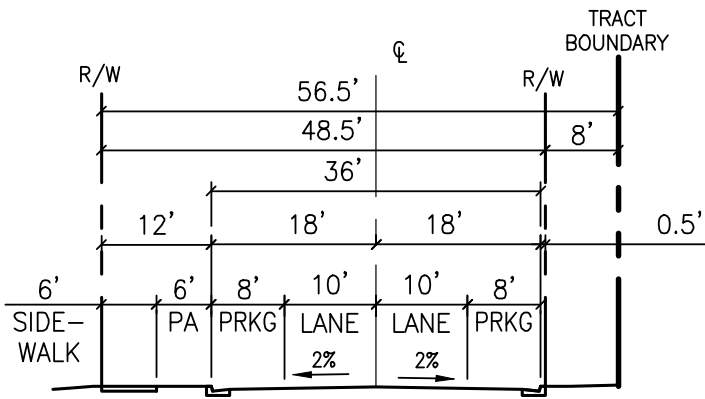
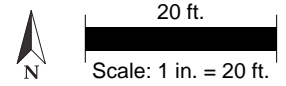

Section A: Sunnyside Ave.

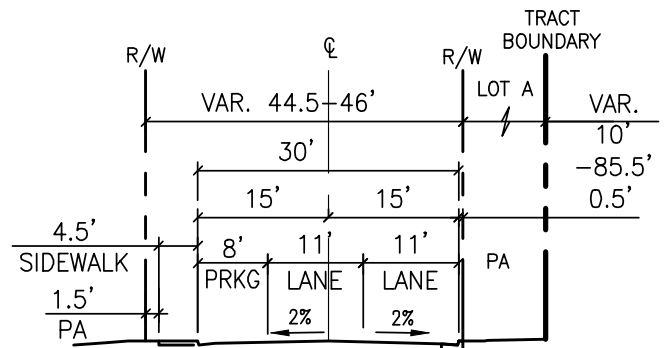

Section E: Carter Ave.

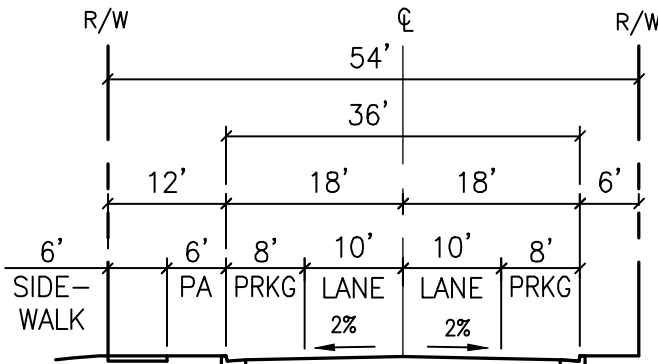

Section B: Sunnyside Ave.

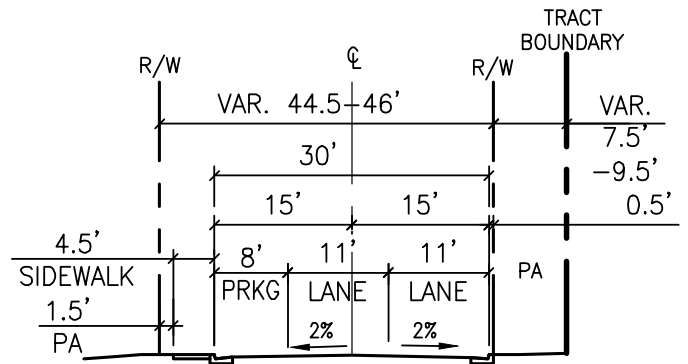

Section F: Carter Ave.

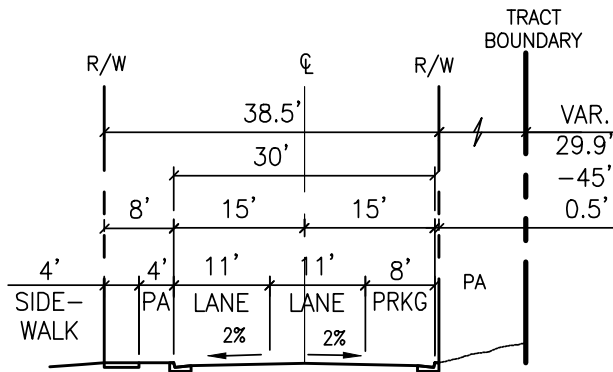

Section C: Street A

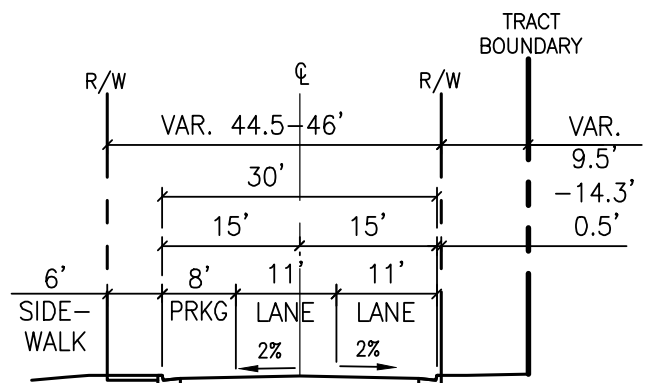

Section G: Carter Ave.

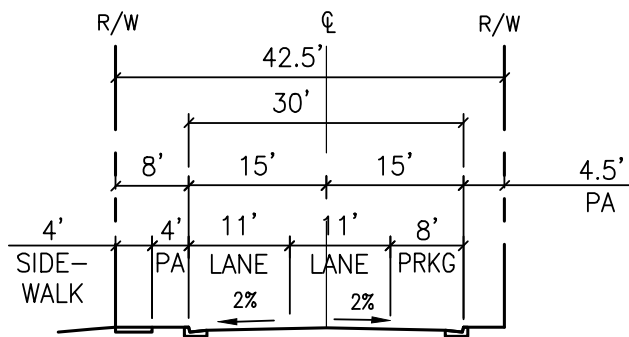

Section D: Streets B and C

Note: Refer to Figure 3-4a for cross section locations

Figure 3-4b: Street Cross Sections



The cross sections for Sunnyside Avenue, Carter Avenue, and the three local streets are provided in **Figure 3-4b, Street Cross Sections**, and described below.

### North Sunnyside Avenue

North Sunnyside Avenue will be a public street with one vehicular lane in each direction providing primary vehicular access to and from the Plan area and public park, internal circulation for the residential area, and access through the Plan area to the Retreat Center. A sliding gate will be located at the Retreat Center's entrance on the northern end of the North Sunnyside Avenue extension, just north of the Plan area boundary. Due to the low thru traffic anticipated entering the Retreat Center, a queue of cars is not expected to form south of the gate within the Plan area. North Sunnyside Avenue will have a maximum 56.5-foot right-of-way with curbs and gutters, parking (see **Figure 3-4a** for details) and planting areas on both sides, and a sidewalk on the west side. North Sunnyside Avenue is depicted in cross-sections A and B in **Figure 3-4b, Street Cross Sections** (see **Figure 3-12a and c, Conceptual Street & Wall Sections**, for additional details).

### Carter Avenue

Carter Avenue will be a public street with one vehicular lane in each direction providing secondary vehicular access to and from the Plan area and public park, internal circulation for the residential land uses and public park, and access through the Plan area to the Retreat Center. In the southeast corner of the Plan area, Carter Avenue will provide access to the public park's parking lot, a secondary access route for vehicles entering and exiting from the Plan area to the existing Carter Avenue, and pedestrian access to the Plan area.

As part of the off-site improvements of the Specific Plan, an existing segment of Carter Avenue outside of the Plan area boundaries that will provide access into the Plan area will be widened to include a 24-foot roadway (10 feet for each travel lane plus one 4-foot planting area along the southern boundary of Carter Avenue). In addition, the off-site improvements on Carter Avenue will include a 5.5-foot sidewalk to be built as one of two alignment options permitted under the Specific Plan. The two alignments, shown on **Appendix 3B, Offsite Improvement Plan**, include option 1, a straight sidewalk on the north side of Carter Avenue extending from Oak Crest Drive to the Plan area, or option 2, a curved sidewalk on the north side of Carter Avenue that meanders through a portion of Bailey Canyon Wilderness Park.

Within the Plan area, the street will have a maximum 46-foot right-of-way with curbs and gutters and planting areas on both sides. A sidewalk, as well as parking (see **Figure 3-4a** for details), will be located on the west side of the street. A pedestrian path extending from the east side of Carter Avenue will provide pedestrian access to Bailey Canyon Wilderness Park, and a crosswalk will provide a safe pedestrian crossing from the offsite sidewalk on Carter Avenue to the sidewalk within the Plan area. Carter Avenue is depicted in cross-sections E, F and G in **Figure 3-4b, Street Cross Sections** (see **Figure 3-12b and c, Conceptual Street & Wall Sections**, for additional details).

### A, B, and C Streets

Streets A, B, and C will run east-west beginning at North Sunnyside Avenue and ending at Carter Avenue. All three streets will be public streets with one vehicular lane in each direction providing internal

- Standard Site Pedestrian Pavement  
Potential Materials:
    - Natural gray paving with etched or broom finish
    - Decomposed granite
    - Integral color concrete with etched finish
    - Precast concrete pavers
  - Specialized Resilient Surfacing
  - Enhanced Vehicular Pavement at Project Entry  
Potential Materials:
    - Integral color concrete with decorative scoring
    - Precast concrete pavers
- \*A variety of materials will be utilized as appropriate in different conditions.



**Figure 3-5: Paving and Pedestrian Plan**

Note: Refer to **Appendix 3A, Figure Enlargements** for plan details.

circulation for the residential land uses. The streets will have a maximum 42.5-foot right-of-way with curbs and gutters and planting areas on both sides of the street, parking located on the north side of the street (see **Figure 3-4a** for details), and a sidewalk on the south side of the street. Street A is depicted in cross-section C and Streets B, and C are depicted in cross-section D in **Figure 3-4b, Street Cross Sections** (see **Figure 3-12a, Conceptual Street & Wall Section**, for additional details).

#### 3.4.4 Pedestrian and Paving Plan

**Figure 3-5, Pedestrian and Paving Plan**, shows the location of sidewalks, pedestrian pathways, and enhanced vehicular pavement in the Plan area. Paving on site includes a 'Standard Pedestrian Pavement' and an 'Enhanced Vehicular Pavement.' Sidewalks and pedestrian pathways, composed of the Standard Pedestrian Pavement as shown on **Figure 3-5**, are located along the west side of North Sunnyside Avenue, the south side of streets A, B, and C, and the west side of Carter Avenue creating a connection between Street A to the public park (potential material options are called out on **Figure 3-5**). A pedestrian path extending from the east side of Carter Avenue will provide pedestrian access to Bailey Canyon Wilderness Park. In addition, as detailed in **Appendix 3B, proposed off-site improvements**, which will include a sidewalk along the north side of Carter Avenue just outside of the Plan area boundaries, will provide pedestrian access to the entrance/parking lot of Bailey Canyon Wilderness Park from the Plan area and increase pedestrian connectivity to the Plan area. (Refer to **Appendix 3B, Offsite Improvement Plan**, for additional details regarding the proposed off-site widening of Carter Avenue.) On

the southern end of North Sunnyside Avenue, there will be Enhanced Vehicular Pavement upon entry to the Plan area, which extends to the sidewalk leading into the public park. The sidewalk on the west side of North Sunnyside Avenue will terminate at the southern Plan area boundary as there are no sidewalks on the existing North Sunnyside Avenue outside of the Plan area. For additional Pedestrian and Paving Plan figure details, refer to **Appendix 3A, Figure Enlargements**.

### 3.5 Landscape Plan

The Specific Plan's Conceptual Landscape Plan (Landscape Plan) is shown on **Figure 3-6a through 3-6b, Conceptual Landscape Plan**. The Landscape Plan focuses primarily on the use of fire-resistant and drought tolerant tree and plant species to create a natural and safe environment. All plant species listed, both native and non-native, have been chosen due to their ability to thrive in the Sierra Madre climate. **Figures 3-7a and b, Tree and Planting Plan**, include the location of trees and types/ species of trees that will be planted in the Plan area, including approximately 490 trees throughout the Plan area, and a planting palette for shrubs, groundcover, and vines developed in consultation with the Sierra Made Community Forest Management Plan and Los Angeles County's Fuel Modification Guidelines for permissible plants within the Very High Fire Hazard Severity Zones (VHFHSZ) (see subsections **3.8.7.ix, Fire Prevention**, and **3.8.7.x, Landscaping Requirements**, for additional details). For additional Tree and Planting Plan figure details, refer to **Appendix 3A, Figure Enlargements**. For conceptual graphics of trees and plantings along street sections, and trees and plantings adjacent to walls refer to **Section 3.7, Wall and Fence Plan**.





Figure 3-6a: Conceptual Landscape Plan





Figure 3-6b: Conceptual Landscape Plan



**Street Trees**



Arbutus "Marina" - STD - Marina Strawberry Tree  
 Lagerstroemia SPP. - STD. - Crape Myrtle  
 Koelreuteria Paniculata - STD. - Golden Rain Tree

**Slope Trees**



Arbutus Unedo - Multi - Strawberry Tree  
 Cercis Occidentalis - Multi - Western Redbud  
 Lophostemon Confertus - Brisbane Box

**Park Trees**



Platanus Racemosa - Western Sycamore  
 Olea Fruitless - Fruitless Olive  
 Quercus Agrifolia - Coast Live Oak  
 Quercus Virginiana - Southern Live Oak



General Planting Areas (Shrubs, Groundcover, and Vines)



Turf (Species TBD)

Vines shall be planted on walls facing park and public open spaces to minimize potential for graffiti.

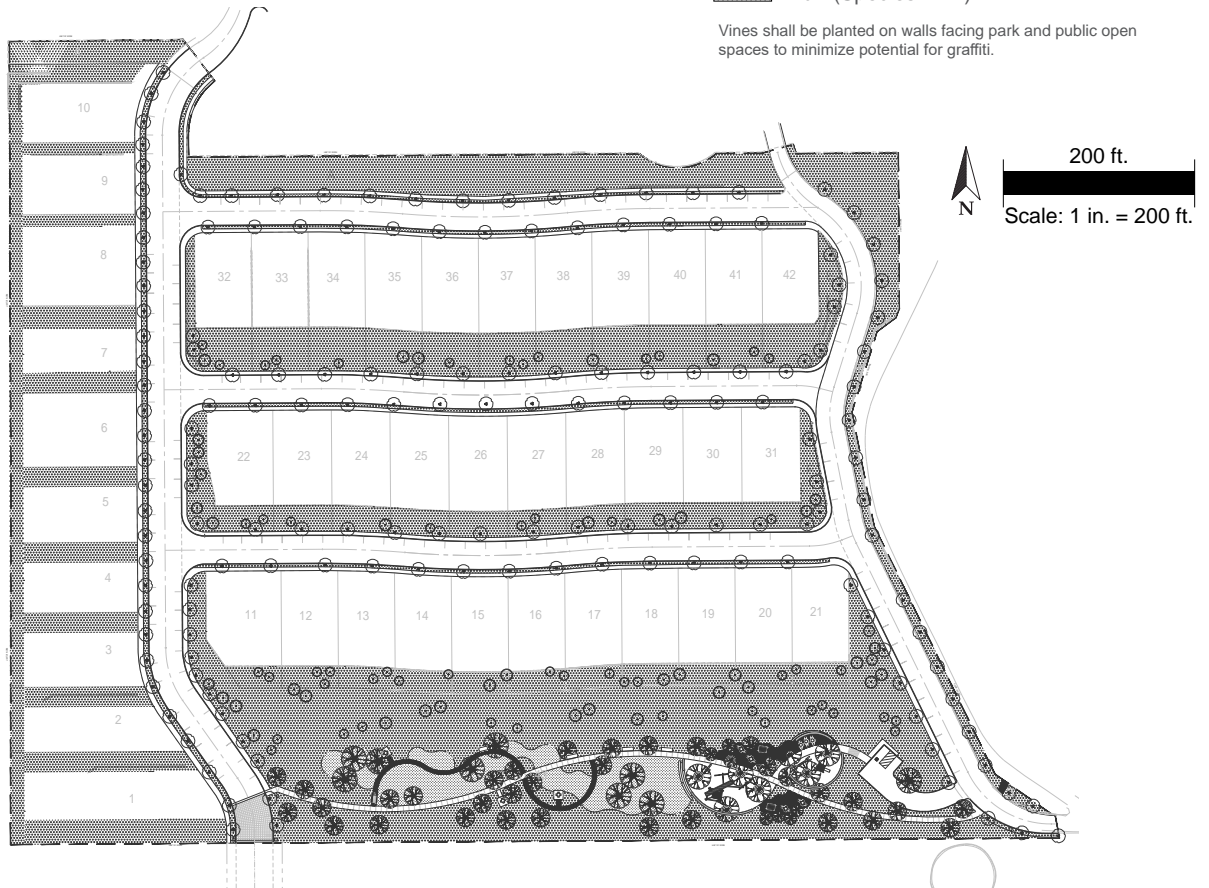

**Figure 3-7a: Tree and Planting Plan**

Note: Refer to **Appendix 3A, Figure Enlargements** for plan details.



# PLANT PALETTE

## TREES



### STREET TREES

ARBUS 'MARINA' - STD. (MARINA STRAWBERRY TREE)  
LAGERSTROEMIA SPP. - STD. (CRAPE MYRTLE)  
KOELREUTERIA PANICULATA - STD. (GOLDEN RAIN TREE)



### SLOPE TREES

ARBUS UNEDO - MULTI - (STRAWBERRY TREE)  
CERCIS OCCIDENTALIS - MULTI (WESTERN REDBUD)  
LOPHOSTEMON CONFERTUS (BRISBANE BOX)



### PARK TREES

PLATANUS RACEMOSA (WESTERN SYCAMORE)  
OLEA FRUITLESS (FRUITLESS OLIVE)  
QUERCUS AGRIFOLIA (COAST LIVE OAK)  
QUERCUS VIRGINIANA (SOUTHERN LIVE OAK)

## GROUNDPLANE PLANTING



### LARGE ACCENT SHRUBS

ALOE MEDUSA (TREE ALOE)  
CALLIANDRA HAEMATOCEPHALA (PINK POWDER PUFF)  
CEREUS PERUVIANUS (PERUVIAN APPLE)  
DRACAENA DRACO (DRAGON TREE)  
HETEROMELES ARBUTIFOLIA (TOYON)  
HIBISCUS ROSA-SINENSIS (CHINESE HIBISCUS)  
PRUNUS ILLICIFOLIA (CATALINA CHERRY)  
RHUS INTEGRIFOLIA (LEMONADE BERRY)  
STRELITZIA NICOLAI (GIANT BIRD OF PARADISE)  
THEVETIA PERUVIANA (YELLOW OLEANDER)

### MEDIUM MASSING SHRUBS

ARBUS UNEDO 'COMPACTA' (STRAWBERRY TREE)  
ARCTOSTAPHYLOS SPP. (MANZANITA)  
BACCHARIS SPP. (COYOTE BRUSH)  
BOUGAINVILLEA SPP. (BOUGAINVILLEA)  
CALLISTEMON SPP. (BOTTLEBRUSH)  
CAMELLIA SPP. (CAMELLIA)  
CEANOTHUS SPP. (WILD LILAC)  
HYDRANGEA MACROPHYLLA (BIGLEAF HYDRANGEA)  
OLEA EUROPAEA 'MONTRA' (LITTLE OLLIE DWARF OLIVE)  
PITTOSPORUM TOBIRA SPP. (JAPANESE MOCK ORANGE)  
RHAMNUS CALIFORNICA (CALIFORNIA COFFEEBERRY)  
RHAPHIOLEPIS INDICA SPP. (INDIA HAWTHORN)  
RHAPHIOLEPIS UMBELLATA SPP. (YEDDA HAWTHORN)  
STRELITZIA REGINAE (BIRD OF PARADISE)  
WESTRINGIA SPP. (COAST ROSEMARY)

### SMALL ACCENT SUCCULENTS, ORNAMENTAL GRASSES,

AGAVE SPP. (AGAVE)  
ALOE SPP. (ALOE)  
CARISSA MACROCARPA (NATAL PLUM)  
CISTUS SPP. (ROCKROSE)  
CLIVIA MINIATA (KAFFIR LILY)  
COTONEASTER SPP. (COTONEASTER)  
DASYLIRION WHEELERI (DESERT SPOON)  
HESPERALOE PARVIFLORA (RED YUCCA)  
MYOPORUM PARVIFOLIUM 'PUTAH CREEK' (PUTAH CREEK MYOPORUM)  
PELARGONIUM PELTATUM (IVY GERANIUM)  
ROSA SPP. (ROSE)  
ROSMARINUS OFFICINALIS (ROSEMARY)  
TRACHELOSPERMUM SPP. (STAR JASMINE)

### VINES

BOUGAINVILLEA SPP. (BOUGAINVILLEA)  
CLYTOSTOMA CALLISTEGIOIDES (VIOLET TRUMPET VINE)  
DISTICTIS BUCCINATORIA (BLOOD-RED TRUMPET VINE)  
HARDENBERGIA VIOLACEA (LILAC VINE)  
PANDOREA JASMINOIDES (BOWER VINE)  
PYRACANTHA SPP. (FIRETHORN)  
TRACHELOSPERMUM JASMINOIDES (STAR JASMINE)  
VIGNA CARACALLA (SNAIL VINE)  
WISTERIA SPP. (WISTERIA)



### TURF

SPECIES TO BE DETERMINED

### GRASSES AND MEADOWS PERENNIALS PLANTINGS

ACHILLEA MILLEFOLIUM (COMMON YARROW)  
AGAVE SPP. (AGAVE)  
ASCLEPIAS SPP. (MILKWEED)  
CAREX SPP. (SEDGE)  
CHONDRPETALUM SPP. (CAPE RUSH)  
CORDYLIN SPP. (GRASS PALM)  
DIANELLA SPP. (FLAX LILY)  
DIETES SPP. (FORTNIGHT LILY)  
ECHINACEA SPP. (CONEFLOWER)  
EUPHORBIA SPP. (SPURGE)  
FESTUCA SPP. (FESCUE)  
HELICTOTRICHON SEMPERVIRENS (BLUE OAT GRASS)  
HEMEROCALLIS SPP. (DAYLILY)  
JUNCUS SPP. (RUSH)  
LANTANA MONTEVIDENSIS (TRAILING LANTANA)  
LEYMUS CONDENSATUS SPP. (GIANT WILD RYE)  
LOMANDRA SPP. (MAT RUSH)  
MISCANTHUS SPP. (SILVER GRASS)  
MUHLENBERGIA SPP. (MUHLY)  
PENNISETUM 'FAIRY TAILS' (EVERGREEN FOUNTAIN GRASS)  
PENSTEMON SPP. (PENSTEMON)  
PHLOMIS SPP. (JERUSALEM SAGE)  
RUSSELLIA EQUISETIFORMIS (FIRECRACKER PLANT)  
SALVIA SPP. (SAGE)  
SENECIO SPP. (GROUNDSEL)  
SESLERIA AUTUMNALIS (AUTUMN MOOR GRASS)  
YUCCA RECURVIFOLIA (SOFT LEAF YUCCA)

### STORMWATER TREATMENT

CAREX SPP. (SEDGE)  
CHONDRPETALUM SPP. (CAPE RUSH)  
FESTUCA SPP. (FESCUE)  
HELICTOTRICHON SEMPERVIRENS (BLUE OAT GRASS)  
JUNCUS SPP. (RUSH)  
LEYMUS CONDENSATUS SPP. (GIANT WILD RYE)  
MISCANTHUS SPP. (SILVER GRASS)  
MUHLENBERGIA SPP. (MUHLY)  
SESLERIA AUTUMNALIS (AUTUMN MOOR GRASS)

Figure 3-7b: Tree and Planting Plan

Based on the Specific Plan EIR, 101 existing trees, including 10 coast live oak (*Quercus agrifolia*) trees, were identified for removal within the Plan area. The tree removal will be consistent with the City's Tree Preservation and Protection Ordinance of the SMMC, Chapter 12.20 Tree replacement, and evaluation for the potential translocation/transplanting of existing heritage oak trees, will be consistent with the requirements in accordance with the mitigation guidelines described in Section 12.20.040, Tree removal – Tree trimming, of the SMMC.

The northern portion of the Landscape Plan includes the grading and landscape buffer along the northern boundary of the Plan area. This area is envisioned to provide a landscape buffer and screening between the Retreat Center's existing amphitheater and lookout point and the proposed one- and two-story homes on the northern end of the Plan area. The buffer will incorporate the existing tree massing and landscaping on the Retreat Center parcel and the tree and plant species chosen within the Landscape Plan. The buffer may include slump block walls (see **Section 3.7, Wall and Fence Plan**, for details).

Once construction of the public park is completed, a landscape maintenance district (LMD), or similar public maintenance district, will be created and administered by the City for the maintenance of the public park and maintenance of open space, including the slopes between homes and open space lots upon buildout as shown on **Figure 3-8, Open Space Plan**. The Retreat Center will maintain the grading and landscape buffer shown in blue on **Figure 3-8**, along the northern Plan area boundary. See **Chapter 4** for water systems details.

## 3.6 Park Plan

The Park Plan, shown in **Figure 3-9, Conceptual Parks and Recreation Plan**, illustrates the conceptual neighborhood park design and recreation facilities that may be accessible to the public.

The approximately three-acre neighborhood park is anticipated to offer outdoor, publicly accessible amenities and natural features. The park shall include recreational amenities such as resilient play surfacing, slope slide, play structure and features, seat walls, benches, picnic areas, large turf areas, a small parking lot reserved for accessible parking and loading only, decomposed granite trail, and a water quality treatment and detention basin, further discussed in **Chapter 4, Infrastructure Plan. Figures 3-10a through 3-10b, Conceptual Park/ Recreation Imagery**, provides character imagery for the conceptual parks and recreation design. A subsequent public design process will further provide an opportunity to incorporate the preferences of community members regarding the recreational amenities of the public park. As part of the subsequent public design process, the final park design will be presented to the City's Community Services Commission for review after a public input process. Refer to **Section 6.2.4, Final Public Park Design**, for implementation procedures related to approval of the park's final design.

The park will be publicly accessible from North Sunnyside Avenue or via Carter Avenue on the southern portion of the Plan area. As shown in **Appendix 3B**, a proposed crosswalk in the southeast corner of the Plan area will provide a pedestrian connection from the new off-site sidewalk on Carter Avenue to the new

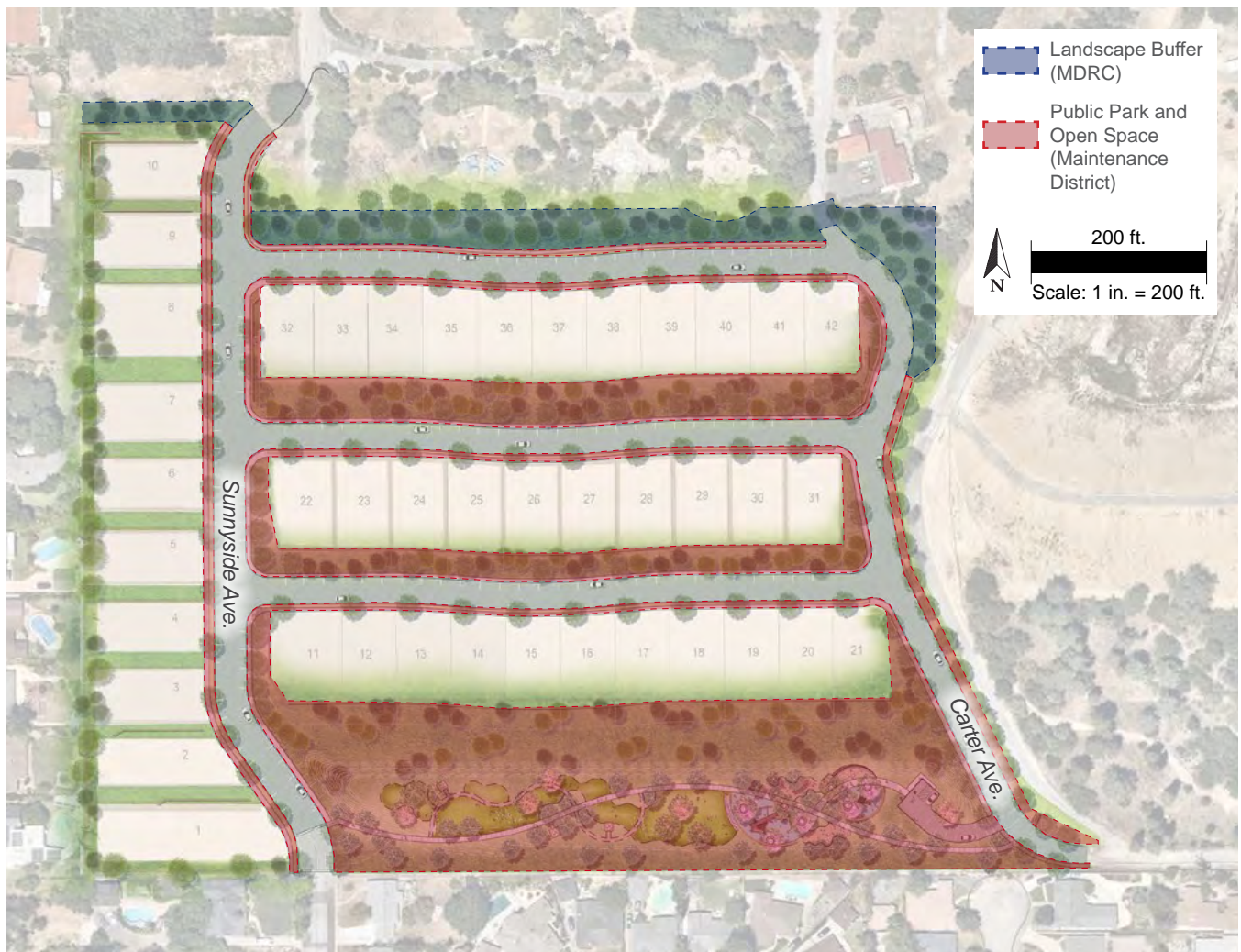

Figure 3-8: Open Space Plan



Figure 3-9: Conceptual Parks and Recreation Plan



public park. A limited access pedestrian connection from Crestvale Drive to the park may be evaluated as a future option. The pedestrian connection would be evaluated under City consideration in consultation with the existing neighbors south of the Plan area. Use of the pedestrian connection would be limited through a key and offer access to the park for adjacent residents only.

The parking lot, reserved for accessible parking spaces as required by law and loading only, will be located on the east side of the park off Carter Avenue and is proposed to include two ADA-compliant parking spaces as shown on **Figure 3-8**. The park's location along the southern boundary of the Plan area provides enhanced connectivity to the Bailey Canyon Wilderness Park by providing a pedestrian pathway extending east of Carter Avenue, as shown on **Figure 3-5**.

The shrubs, groundcover, vines, and trees along the southern border of the public park will provide a landscape buffer between the Plan area and the existing adjacent homes to the south. However, to preserve views and privacy for existing homes south of the Plan area, there will be an 18-foot buffer between the property line of existing residences and the public park, which will include a berm on which trees will not be planted and shrubs will be used for landscaping. On the north side of the 18-foot buffer area, a six-foot view fence is proposed to maintain the berm as a buffer area. Conceptual sections of the park buffer are enlarged and shown in **Appendix 3C, Conceptual Park Buffer Sections**.

### 3.7 Wall and Fence Plan

The Specific Plan's Wall and Fence Plan, shown in **Figures 3-11a, Wall and Fence Plan**, and **3-11b, Wall and Fence Imagery**, provides the approximate location of slump block walls, top of slope view fences, and retaining walls (for additional Wall and Fence Plan figure details, refer to Appendix 3A, Figure Enlargements). Slump block walls will be primarily located near the northern, southern, and western Plan area boundary, as well as between residential lots. Top of slope view fences will be primarily located in the rear of the residential lots on Streets A, and C, and the eastern half of residential lots on Street B, as well as near the eastern Plan area boundary.

Retaining walls will be primarily located between the southernmost and northernmost residential lots west of North Sunnyside Avenue, as well as portions along the east side of North Sunnyside Avenue, principally near the park and open space lot C, and portions along Carter Avenue principally near open space lots B and E. Wall locations are preliminary and may be subject to change during final design provided that all walls will adhere to the standards provided in this Specific Plan.

**Figures 3-12a through c, Conceptual Street and Wall Sections**, provide conceptual graphics of trees and plantings and walls along street sections, including heights and materials. As shown on **Figures 3-12 a through c**, where multiple walls are used, walls will be terraced, and plantings will be used to provide screening in accordance with the requirements of the Specific Plan.



Figure 3-10a: Conceptual Park/Recreation Imagery



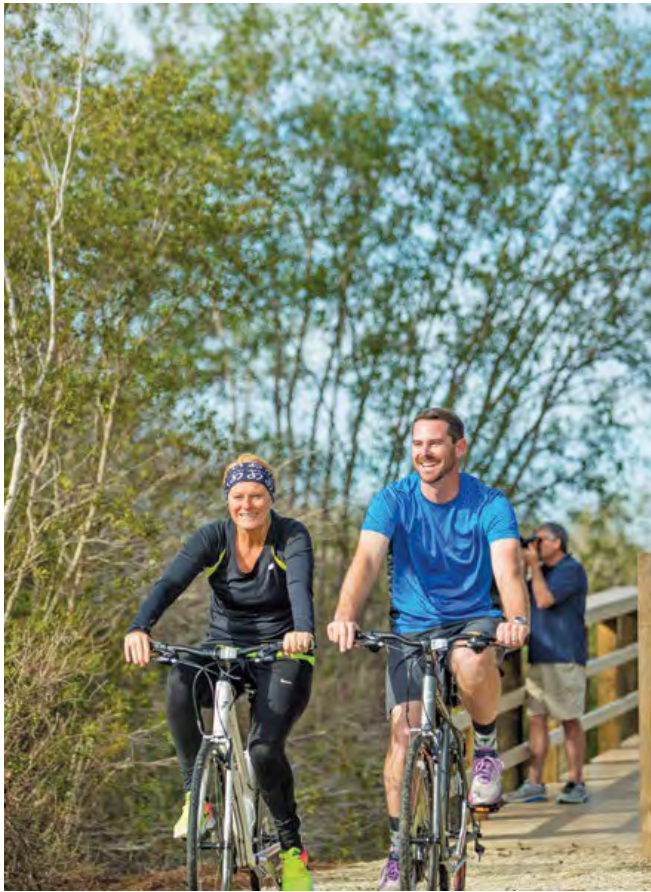
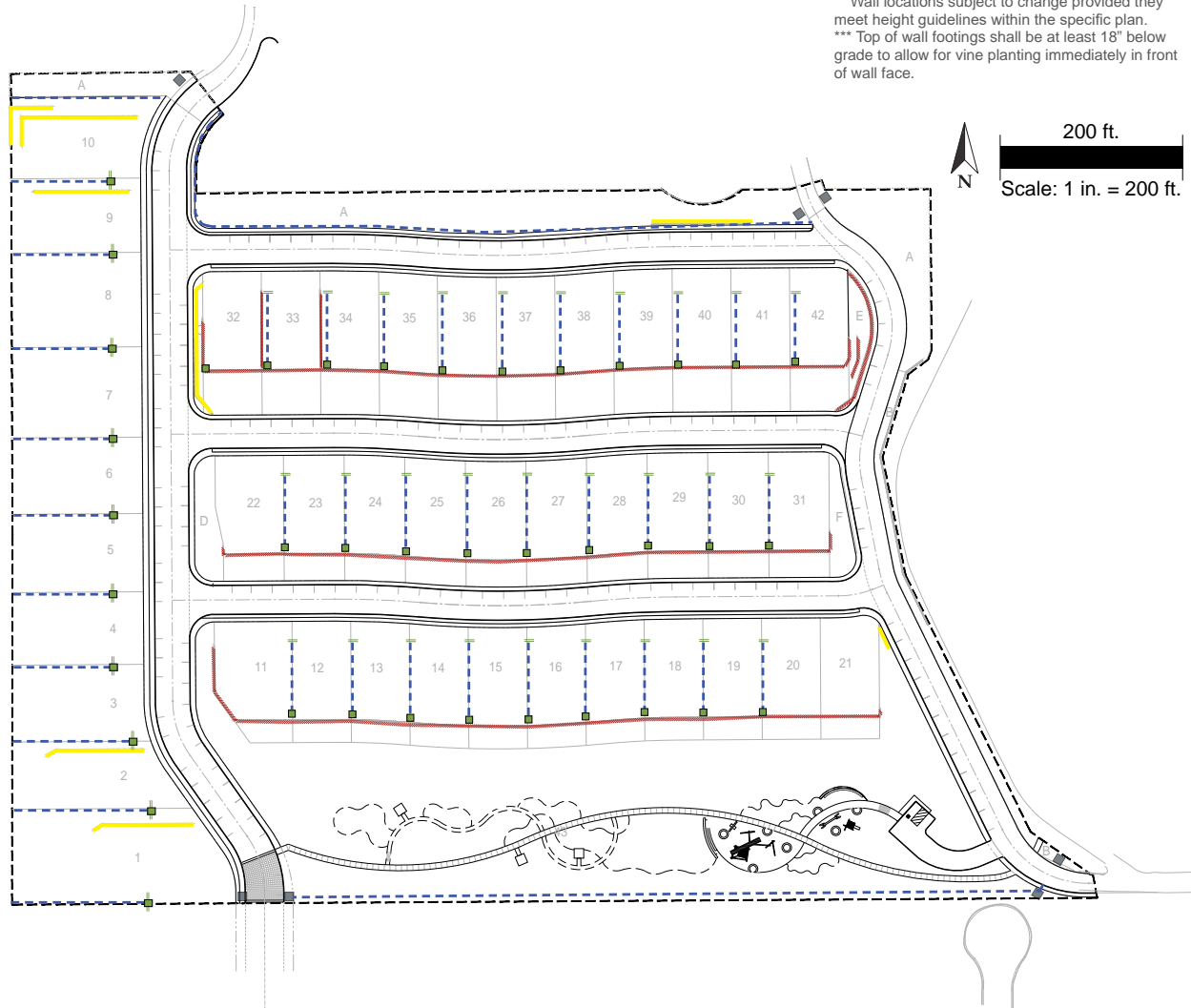

Figure 3-10b: Conceptual Park/Recreation Imagery



- Slump Block
- Slump Block with Sac Finish
- Top of Slope View Fence
- Retaining Wall (Height Varies)
- Slump Block Pilaster with Sac Finish
- Thematic Community Pilaster /Monument

\*Vines shall be planted on walls facing park and public open spaces to minimize potential for graffiti.  
 \*\* Wall locations subject to change provided they meet height guidelines within the specific plan.  
 \*\*\* Top of wall footings shall be at least 18" below grade to allow for vine planting immediately in front of wall face.



**Figure 3-11a: Wall and Fence Plan**  
 Note: Refer to **Appendix 3A, Figure Enlargements** for plan details.



----- Top of Slope View Fence



----- Slump Block with Sac Finish



----- Retaining Wall (Height Varies)



----- Slump Block

**Figure 3-11b: Wall and Fence Imagery**



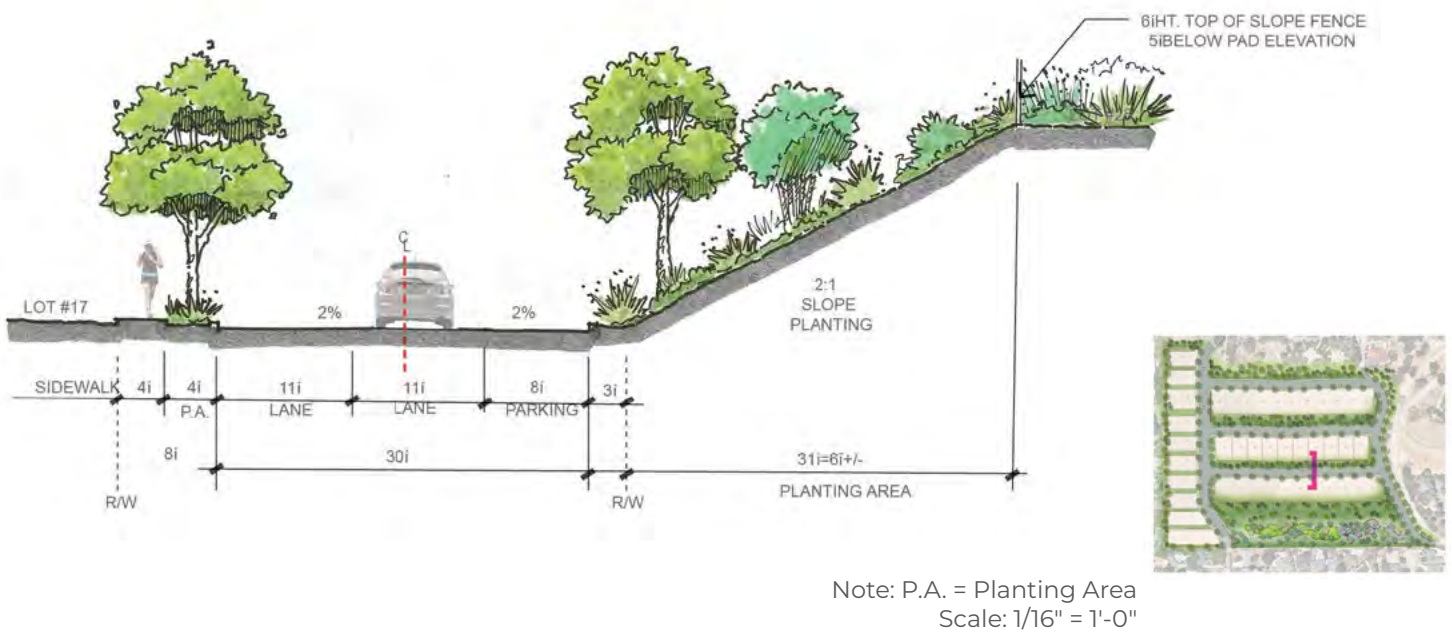
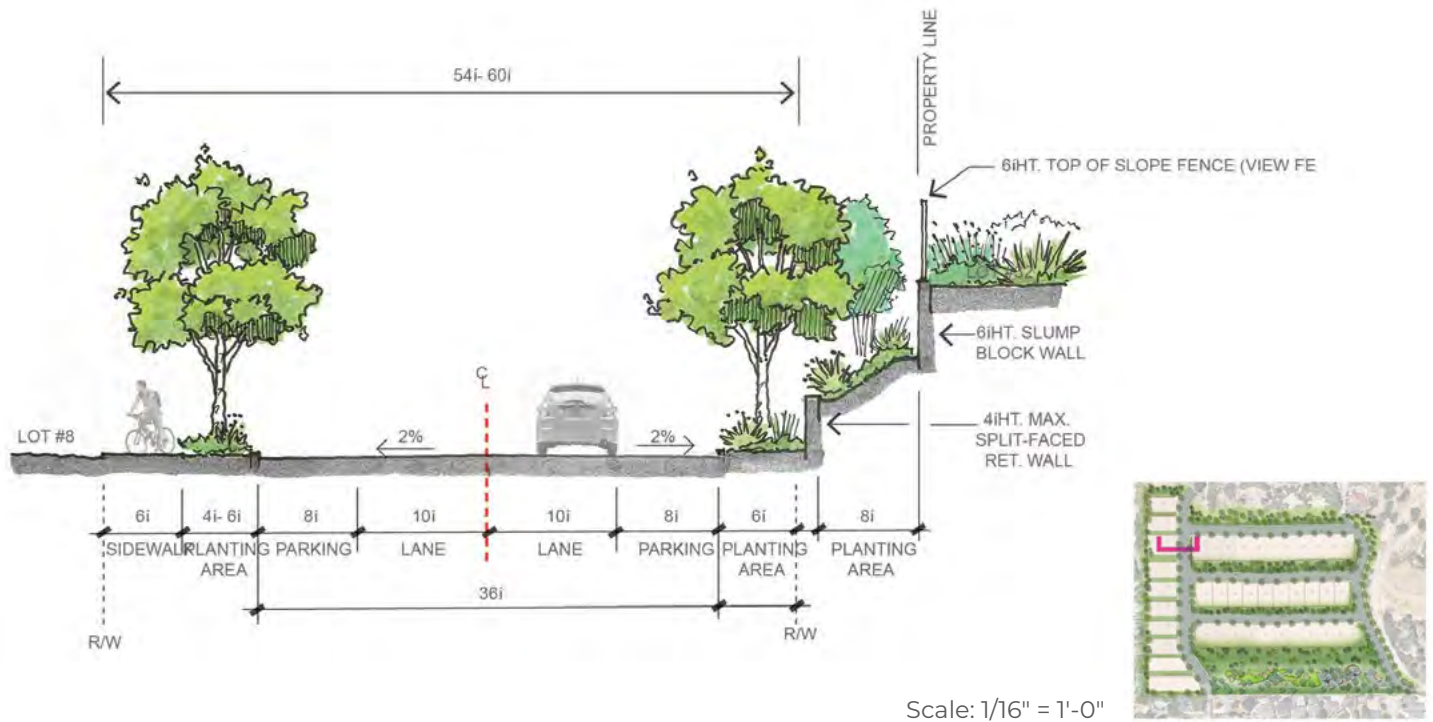
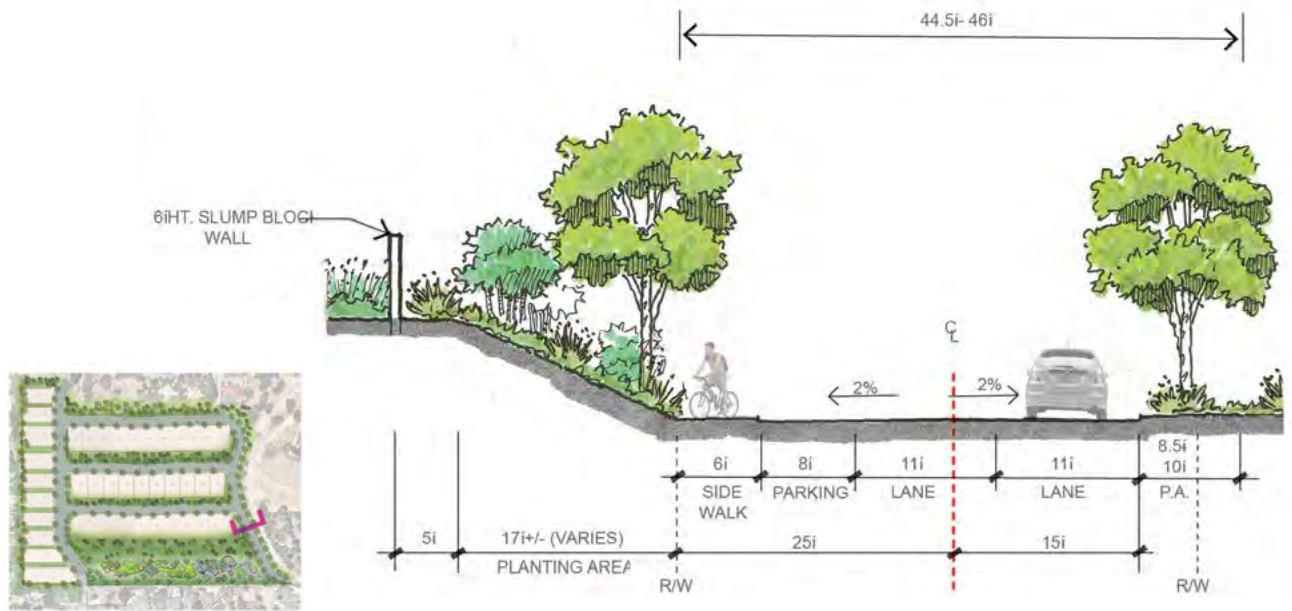
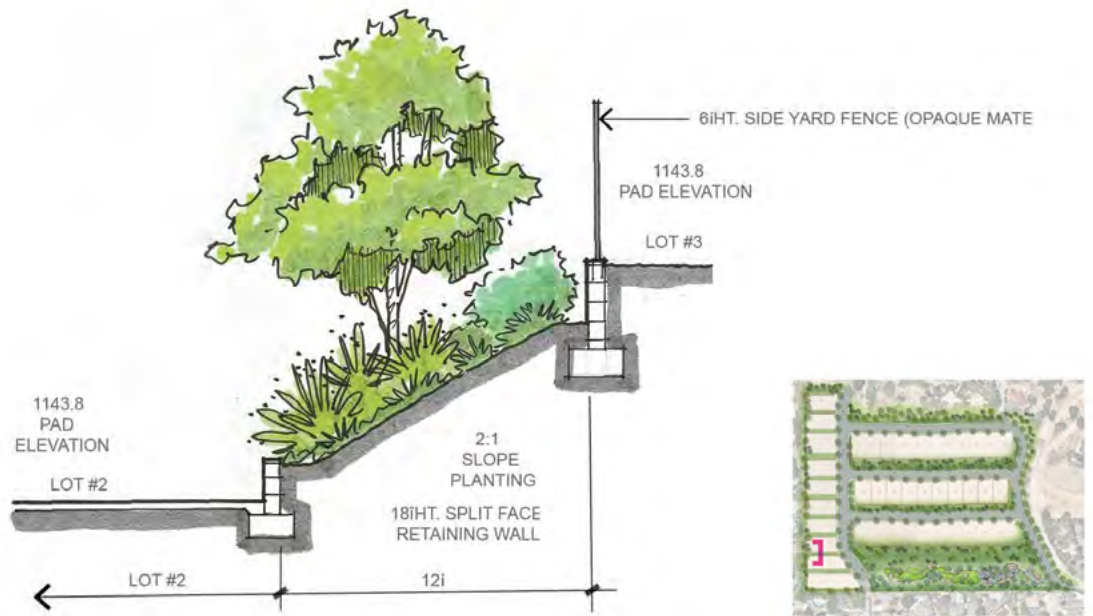

Figure 3-12a: Street and Wall Sections





Scale: 1/16" = 1'-0"



Scale: 1/8" = 1'-0"

Figure 3-12b: Street and Wall Sections

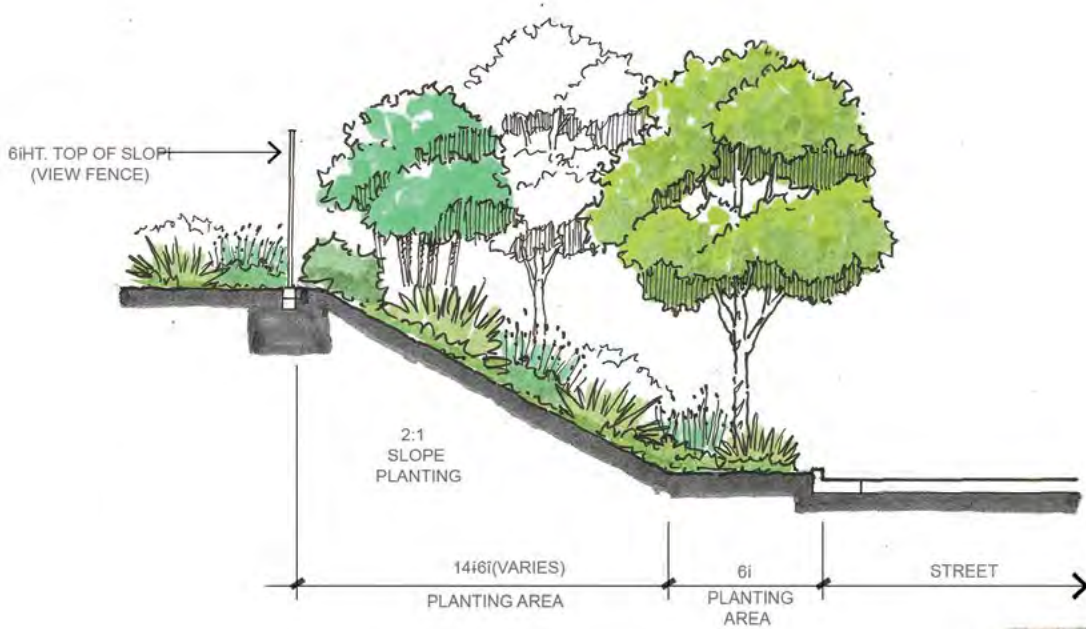

Scale: 1/18" = 1'-0"



Scale: 1/18" = 1'-0"



Figure 3-12c: Street and Wall Sections

## 3.8 Development Standards

This section provides regulations for the development of land uses within the Specific Plan and describes how these development regulations will be used as part of the City's development review process. Proposed development, subdivisions, and new land uses within the Plan area must comply with all applicable requirements of this Specific Plan.

### 3.8.1 Consistency with Adopted Plans

As required by Government Code Sections 65454 and 65455, upon adoption, the Specific Plan must include a statement of the relationship of the Specific Plan to the City's adopted General Plan. **Appendix 1A, General Plan Consistency Analysis**, provides an analysis of the Specific Plan's consistency with the applicable goals of the City's General Plan. The Specific Plan's development standards will implement the applicable goals and policies of the General Plan, and as such, all subsequent land use entitlements and permits (e.g., EIR Certification, General Plan Amendment, Zone Change, Meadows Specific Plan, Tentative Tract Map, Lot Line Adjustment, and Development Agreement) implementing the Specific Plan must also be consistent with the goals and policies of the General Plan.

### 3.8.2 Relationship to City of Sierra Madre Zoning Code

The Specific Plan, including the development regulations, are intended to provide a comprehensive set of regulations governing the use and development of the land within the Plan area. These development regulations replace the

requirements of the City's Zoning Code, Titles 16 and 17 of the SMMC. Any matter or issue not specifically and directly covered by this Specific Plan shall be subject to the nonconflicting regulations and procedures of the SMMC, including Chapter 17.20, R-1 One-Family Residential Zone. If a conflict arises between the Specific Plan and the City's Zoning Code, the provisions of this Specific Plan shall control.

### 3.8.3 Administration

The regulations, standards, and other requirements of this Specific Plan shall be administered and enforced by the City's Planning & Community Preservation Department, Planning Commission, and City Council in the same manner as the provisions of the City's Zoning Code.

### 3.8.4 Allowed Land Uses/Permit Requirements

This section sets forth the permitted land uses within the RL and OS zones. Each land use type identified in this section is defined in **Section 3.3.1, Zoning Designations**.

These definitions shall be applied within the Plan area.

Any one or more land uses identified in this section as allowed land uses within a specific zone may be established on any parcel within that zone, subject only to the planning permit requirements. Temporary uses are allowed within the Plan area in compliance with the Temporary Use Permit requirements of the SMMC, Chapter 17.88, Temporary Use Permits.



## A. Residential Low Density Use Types

The following uses shall be permitted by right in the RL zone within the Plan area.

### i. Primary Uses

A primary use is the main principal use of land or structures on the site. The following uses are permitted by right as Primary Uses in the RL zone:

- a. One-family dwellings

### ii. Secondary Uses

Where a primary use is established on a development site, secondary uses may also be permitted. A secondary use is a use that is not the primary use and not the main use of land or structures on the development site. A secondary use is incidental to or in support of the primary use(s) on the same development site or another development site within the RL land use zone of this Specific Plan.

The following categories of uses that are allowed in the RL zone are permitted by right as secondary uses:

- a. Home occupations<sup>1</sup>
- b. Guest houses<sup>2,3</sup>
- c. Accessory dwelling units<sup>4</sup>
- d. Swimming pools<sup>5</sup>
- e. Family day care home, small<sup>6</sup>
- f. Vehicle Parking<sup>7</sup>

1 Pursuant to the provisions in SMMC, Chapter 17.85, Home Occupations.

2 See SMMC, Section 17.08.020, Words, terms, phrases, defined.

3 Pursuant to provisions in SMMC, Section 17.20.060.A, Detached Accessory Structures; however, guest houses within the Plan area shall measure six hundred square feet or less.

4 Pursuant to the provisions in SMMC, Section 17.22, Second Units. Per the SMMC, "Second Units" means the same as "Accessory Dwelling Unit."

5 Swimming pools, hot tubs, spas, and similar recreational facilities pursuant to the provisions in the SMMC, Section 17.20.065, Swimming pools.

6 See SMMC, Section 17.08.020, Words, terms, phrases, defined.

7 Vehicle parking pursuant to the provisions in the SMMC, Section 17.20.020.L, Vehicle Parking.

## B. Open Space Use Types

The following uses shall be permitted by right in the OS zone within the Plan area.

### i. Primary Uses

A primary use is the main principal use of land or structures on the site. The following uses are permitted by right as Primary Uses in the OS zone:

- a. Land that is essentially unimproved or naturally landscaped and devoted, used, or utilized for preservation of natural resources, plant and animal life, ecological and scientific study and purposes, ponds, and watershed
- b. Parks, playgrounds, active and passive recreation areas, and such nonhabitable buildings and structures as are accessory thereto.

### ii. Secondary Uses

- a. Park restrooms and ancillary park buildings including maintenance buildings and sheds
- b. Detention basins and water treatment
- c. Parking lots reserved for accessible parking and loading only

### 3.8.5 Good Neighbor Plan

This section highlights the standards, features and guidelines that are incorporated within the Specific Plan which promote compatibility with the immediately adjacent neighbors and existing uses. Key features promoting the Good Neighbor Plan – particularly to those to the immediate west, include landscaping and a dedicated buffer in the rear of lots west of North Sunnyside Avenue, a use restriction covenant, and increased setbacks for lots west of North Sunnyside Avenue as outlined in **Section 3.8.7, Site Development Standards**. The increased setback requirement includes an additional rear yard setback of 35 feet for all lots west of North Sunnyside Avenue, compared to a 15-foot rear yard setback for lots east of North Sunnyside Avenue. In addition, pursuant to the recorded use restrictions for all lots located west of North Sunnyside Avenue, no structures of any kind (e.g., detached accessory structures, detached garages or carports, miscellaneous structures and uses, etc.) are permitted within a 20-foot setback from the lot's rear property line.

On the southern boundary adjacent to an existing single-family neighborhood, a dedicated public park will serve as a new community amenity, both unifying the community by providing a community gathering space and providing privacy to the existing neighbors by acting as a landscape buffer between the Meadows at Bailey Canyon homes and the existing adjacent homes to the south. The shrubs, groundcover, vines, and trees along the entire southern border of the public park will provide a landscape buffer between the Plan area and the existing adjacent homes. Furthermore, the LMD, or similar public maintenance district, which will be created and administered by the City, will ensure the maintenance of the public park, including landscaping. Therefore, the LMD, or similar public maintenance district,

serves as a mechanism for ensuring the perpetuity of the landscape buffer and privacy for the adjacent neighbors as part of the Good Neighbor Plan.

Along the northern boundary of the Plan area, a grading and landscape buffer on approximately one acre of the Plan area will enhance privacy between the Meadows at Bailey Canyon development and the Retreat Center. This area is envisioned to provide a visual landscape buffer and screening, as well as a wall for noise attenuation between the Retreat Center's existing amphitheater and lookout point and the proposed one- and two-story homes on the northern end of the Plan area, therefore promoting a Good Neighbor Plan for the existing Retreat Center and the Meadows residents. Additionally, the Specific Plan commits to locating proposed one-story homes on key lots along Street A, as shown on **Figure 3-13** and further discussed in **Section 3.8.6**, to thoughtfully preserve views from the existing Retreat Center. The Retreat Center will ensure the maintenance of landscaping in the northern grading and landscape buffer, therefore ensuring the perpetuity of the landscape buffer area and privacy as part of the Good Neighbor Plan.

The Design Standards and Guidelines set forth in **Chapter 5** and the Design Review process set forth in **Chapter 6's** Implementation Procedures, are intended to promote the high-quality standards that the City and the community value. The Design Standards and Guidelines set forth in **Chapter 5** do so by augmenting the requirements of the Development Standards outlined in this section by describing aesthetic and qualitative features in the site, building, and landscape design, such as architectural style and building elements, for example. Additional standards and guidelines for architectural design, including those for well-articulated primary and rear façades, strive to minimize visual impact and create an attractive visual



Zone	Site Development Regulations									Required Parking
	Lot Area Min.	Lot Coverage Min.	Average Floor Area <sup>2</sup>	Gross Floor Area Max.	Building Height Max.	Setbacks Min. <sup>3</sup>				
						Front Yard	Side Yards	Rear Yards		
								Lots East of N. Sunnyside Avenue	Lots West of N. Sunnyside Avenue	
Single-Family Residential	7,800 sq. ft.	50%	3,500 sq. ft.	3,775 sq. ft.	25 ft.	15 ft to main building – 20 ft to garage	5 ft. (each side)	15 ft.	35 ft.	2 enclosed parking spaces per dwelling unit

Note: Min. = minimum; Max. = maximum; sq. ft. = square feet; ft. = feet.

**Table 3-2:** Site Development Standards Matrix (RL Zone<sup>1</sup>)

<sup>1</sup> Development within the OS Zone shall comply with the plans presented in this Specific Plan. In those instances where the Specific Plan is silent, then the City's Zoning Ordinance shall apply for those particular issues and considerations only.

<sup>2</sup> Average across all lots in the Plan area.

<sup>3</sup> Projections into the required front yard setback may occur as provided in this chapter.

quality for adjacent neighbors. In addition, the architectural design guidelines require that rear balconies facing existing units to the west shall be set back at least 35 feet from the property line to ensure the privacy of adjacent neighbors is protected. The Design Standards and Guidelines uphold the Vision and Guiding Principles by describing the City's desired visual, aesthetic, and stylistic character of residential development in the Plan area to produce a consistent and cohesive level of quality in design to further promote a Good Neighbor Plan for the existing and future community members.

### 3.8.6 Site and Housing Plan

In addition to those standards outlined under the Good Neighborhood Plan, the Specific Plan provides a conceptual site plan that thoughtfully takes into account unit siting, building massing and topography. Additionally, the site plan integrates architectural design guidelines and standards of the Specific Plan, including building mass, form, and scale further detailed in **Chapter 5. Figure 3-13, Conceptual Site Plan**, illustrates the location of the proposed 42 one- and two-story detached single-family units within the Plan area.

**Figure 3-13** serves to show the location of one- and two-story homes proposed in the Plan area through illustrative building footprints. The Specific Plan commits to developing one-story homes in the locations shown on **Figure 3-13** to reduce massing within the Plan area, including one-story units on all corner lots on streets A, B, and C; however, building footprints are shown for illustrative purposes only and final plotting may be subject to change during final design in accordance with the standards provided in this Specific Plan.

The proposed one- and two-story homes within the Plan area will be developed in accordance with one of three housing plans (Plans 1, 2 and 3). Plan 1 consists of one-story units and Plans 2 and 3 provide for two-story units. The Specific Plan will provide a minimum of 11 Plan 1 homes (one-story), and proposes 15 Plan 2 homes and 16 Plan 3 homes. (Refer to **Section 3.8.7.viii, Unit Mix Requirements**, for the minimum number of one-story homes (Plan 1) and the maximum number of two-story homes (Plans 2 and 3) that shall be developed within the Plan area.) All three housing plans will be designed to complement the architectural styles set forth in **Chapter 5**.

### 3.8.7 Site Development Standards

This section sets forth the development standards governing the RL zone shown on **Figure 3-1, Land Use Plan**, and described in Section 3.3.1, Zoning Designations. The Specific Plan’s development standards are set forth in **Table 3-2**.

#### A. Development Standards

**Table 3-2** provides the standards for minimum lot areas, maximum lot coverage and floor area, building height requirements, setbacks, and parking. In addition to these development standards, the overall maximum density of the Plan area is 2.5 dwelling units per acre; however, in no event shall the project be permitted to exceed a maximum of 42 primary residential units.

##### i. Lot Area Requirements

The minimum required lot size shall be 7,800 square feet.

##### ii. Lot Coverage Requirements

Buildings, including covered porches and patios, shall have a maximum lot coverage of 50 percent of the area of the lot.

##### iii. Floor Area Requirements

- a. **Maximum Floor Area.** Allowable gross floor area on a single lot shall not exceed 3,775 square feet in accordance with the definition for "gross floor area" set forth in **Section 3.2, Definitions**.
- b. **Average Floor Area.** Average floor area shall not exceed 3,500 square feet across all lots in the Plan area.

##### iv. Building Height Requirements

- a. **Building Height.** No building shall exceed two stories or 25 feet in height, in accordance with the definition for "height" set forth in **Section 3.2, Definitions**.

##### b. Angular Plane Height.

- 1. **Plan 1 Homes - Angle Plane Height.** All Plan 1 (one-story) dwelling units shall comply with the angle plane height requirements set forth in Section 17.20.053, Angle plane, of the SMMC. Existing ground level shall be the grade elevation of the finished pad.

##### v. Setback Requirements

This section sets forth the minimum setback requirements, which shall apply to both the first and second floors.

- a. **Front Yard Setback.** Every lot shall have a minimum front yard setback of at least 15 feet to the main building and at least 20 feet to all garages, except as provided in this chapter.
- b. **Side Yard Setback.** Every lot shall have a side yard setback of at least five (5) feet on each side.
- c. **Rear Yard Setback.**
  - 2. **East of North Sunnyside Avenue.** Lots east of North Sunnyside Avenue shall have a rear yard setback of at least 15 feet.
  - 3. **West of North Sunnyside Avenue.** Lots west of North Sunnyside Avenue shall have a rear yard setback of at least 35 feet.

##### vi. Projections into Required Setbacks

- a. **Architectural Feature Projections.** Eaves, fireplace masonry, and other non-floor area architectural design features, such as window seats, may project and/or encroach into any of the required setback area no more than 24 inches.

**b. Projections into the Front Yard.**

Projections into the required front yard setback may occur as follows:

1. Nonhabitable covered front porch, with or without supports, may encroach a maximum of six (6) feet into the required front yard setback. In no case may the encroachment be closer than 10 feet to the front property line.
2. An open, uncovered balcony (not covered by a roof or similar structural feature) may project into the required front yard setback a maximum of 48 inches.
3. An open balcony, covered only with a roof feature and supports, may extend into the required front yard setback a maximum of 48 inches, pursuant to the approval of an administrative design review permit pursuant to the provisions of Chapter 17.60, Variances and Discretionary Permits, of the SMMC.

**vii. Accessory Structures**

Accessory structures shall be consistent with the selected architectural style of the main building as discussed in **Chapter 5, Design Guidelines.**

Accessory Structures shall comply with the requirements and procedures found within Section 17.20.060, Accessory Structures, of the SMMC; however, detached accessory structures should be located in the rear of the lot<sup>9</sup>.

**viii. Unit Mix Requirements**

Three housing plans (Plans 1, 2 and 3) with one- and two-story homes are proposed to be developed within the Plan area. This section sets forth the minimum number of one-story homes (Plan 1) and the maximum number of two-story homes (Plans 2 and 3) that shall be developed within the Plan area.

In accordance with **Table 3-3, Unit Mix Requirements**, a minimum of 25% of the total units in the Plan area shall be developed in accordance with Plan 1, a maximum of 35% of the total units shall be developed in accordance with Plan 2, and a maximum of 40% of the total units shall be developed in accordance with Plan 3. To the extent that there is a fraction, the number of units can be rounded up, however, a minimum of 11 one-story homes shall be provided and under no circumstances shall the total units within the Plan area exceed 42 detached single-family dwelling units. (See **Section 3.8.6** for additional site plan details.)

<sup>9</sup> Pursuant to the recorded use restrictions for all lots located west of North Sunnyside Avenue, no structures of any kind (e.g., detached accessory structures, detached garages or carports, miscellaneous structures and uses, etc.) are permitted within a 20-foot setback from the lot's rear property line.

Unit Mix Requirements		
Housing Plan	Gross Floor Area	Percentage of Units to be Provided <sup>1</sup>
Plan 1	3,200 sq. ft.	25% min.
Plan 2	3,650 sq ft.	35% max.
Plan 3	3,775 sq. ft.	40% max.

Note: Min. = minimum; Max. = maximum; sq. ft. = square feet; ft. = feet.

<sup>1</sup> Number of units to be calculated as a percentage of the total number of units provided in the Specific Plan area.

**Table 3-3** Unit Mix Requirements



## ix. Fire Prevention

- a. **Fire Protection Criteria.** The Plan area lies within an area considered a Very High Fire Hazard Severity Zone (“VHFHSZ”), as designated by the Los Angeles County Fire Department (“LACoFD”) and California Department of Forestry and Fire Protection (“CAL FIRE”). The VHFHSZ designation does not indicate that an area is not safe for development. Fire hazard designations are based on topography, vegetation, and weather, amongst other factors. The Plan area shall meet applicable code requirements for building in these higher fire hazard areas. Where required, new buildings/structures within the Plan area shall be constructed using fire resistant features and shall meet applicable code requirements for building in these higher fire hazard areas. The requirements include using the most current construction methods intended to mitigate wildfire exposure, required by LACoFD, as well as complying with the wildfire protection building construction requirements, within the established limits by law, contained in the applicable California Building Standards Code and Los Angeles County Codes, including, but not limited to, the following: LA County Building Code, Chapter 7A, [SFM] Materials and Construction Methods for Exterior Wildfire Exposure, LA County Residential Code, Section R337, Materials and Construction Methods for Exterior Wildfire Exposure, LA County Referenced Standards Code, Chapter 12-7A, Materials and Construction Methods for Exterior Wildfire Exposure, and Los Angeles County and California Fire Codes, Chapter 49, as applicable.

- b. **Fuel Modification.** All landscaping within the Plan area shall be maintained in accordance with Chapter 8.36 – Hazardous Brush Clearance, of the SMMC, and the current Fuel Modification Guidelines from the Los Angeles County Fire Department, provided in **Appendix 4A, Fuel Modification by Zone.** To reduce the chance of building loss or damage from a wildfire, buildings/structures within the Specific Plan should maintain 100 feet of Defensible Space from each side and from the front and rear of the structure, but not beyond the property line as required under the Public Resources Code (PRC) 4291. Current CalFire guidelines are provided in **Appendix 4B, CalFire Defensible Space and Hardening.**

## x. Landscaping Requirements

Landscaping requirements within the Plan area shall be addressed as follows:

1. On-site landscaping shall be completed in accordance with the Conceptual Landscape Plan provided in **Figure 3-6, Conceptual Landscape Plan**, and with the Tree and Planting Plan provided in **Figures 3-7a and b.**
2. At least one (1) shade tree within each front yard setback shall be provided for shading on the front of the house and sidewalk.
3. Trees shall be provided in the parkways along the streets to provide shade and aesthetic value, in accordance with **Figure 3-7a, Tree and Planting Plan.**
4. All landscaping projects that meets the applicability criteria set forth in Section 15.60.030 – Applicability of the SMMC, shall

comply with the City's Water Efficient Landscape Ordinance (WELo). Irrigation of all landscaped areas shall be conducted in a manner conforming to the rules and requirements, and shall be subject to penalties and incentives for water conservation and water waste prevention as determined and implemented by the City or as mutually agreed by the City.

5. For all projects that are required to comply with water efficient landscape standards, a conceptual landscape plan shall be submitted to the City to be reviewed in conformance with the landscape plan and standards set forth in this Chapter and consistent with Section 15.04.130 - Permit for landscape project, from the SMMC.
6. Consistent with the City's Water Efficient Landscape Ordinance, landscaping within the Plan area shall use low water use plants and native California plants where possible. In areas where moderate or high use water use plants are needed, they should be limited in number, grouped together in adjacent areas to simplify irrigation strategies, and offset in other areas of the site with low or very low water use plants.
7. **Landscaping and Paving in Front Yard.** A minimum of 40% of the front yard area shall be landscaped. Landscaping shall include plant materials such as trees, shrubs, ground covers, flowers, and turf, and shall exclude areas such as driveways, walkways, landings, porches, patios, and similar areas.

8. Green infrastructure shall be incorporated into the design of the public realm, e.g., bioswales, permeable paving, etc.
9. Where available, greywater or recycled water should be used for landscaping.
10. Appropriate paving materials for exterior hardscape areas include native stone, faux stone that has the appearance of native stone, colored, stamped and/or patterned concrete, pre-cast concrete pavers, decomposed granite, wood, and permeable pavement.

#### **xi. Driveway and Parking Standards**

- a. Two spaces per dwelling unit in a garage; each space shall have a minimum interior dimension of 10 feet × 20 feet, with a minimum floor-to-ceiling height of seven (7) feet.
- b. Each residential lot should be limited to one driveway and one curb-cut.
- c. One driveway apron shall be provided per lot.

#### **xii. Fencing and Walls.**

- a. On-site walls and fencing shall be completed in accordance with the Wall and Fence Plan provided in **Figure 3-11, Wall and Fence Plan.**
- b. **Front Yard Fencing and Property Line Walls.** Fence and wall height should be minimized to avoid a fortress appearance while performing their intended function. Walls within the required front yard setback shall be no more than 42 inches high.
- c. **Fence and Wall Design.** The design and color of fences and walls shall be consistent with the overall design

of the main building. Appropriate materials for walls and fencing include tube steel, river rock stone veneer, split face block, slump stone block, and glass.

d. **Fence and Wall Landscaping.**

Fences and walls should incorporate landscaping, i.e., allow plants to grow around fences and merge with the landscape; however, they shall be in accordance with the current Fuel Modification Guidelines from the Los Angeles County Fire Department, provided in **Appendix 4A**.

e. **Maximum Wall Height.** Wall height shall be no more than six (6) feet while performing their intended function, except for walls along the grading and landscape buffer on the Plan area's northern boundary, which shall be no more than eight (8) feet high.

f. **Retaining Walls.**

1. Retaining walls located upslope from a building or structure shall not exceed six (6) feet in height.
2. Where multiple walls are used, retaining walls shall be terraced.
3. Terraced retaining walls shall be separated by a minimum of three (3) feet and screened by appropriate landscaping in accordance with the Specific Plan's Conceptual Landscape Plan.
4. The total wall height of an upslope wall system shall be no more than 20 feet.

**xiii. Lighting Standards**

a. All lighting of the building, landscaping, parking area, or similar facilities shall comply with the City's "Dark Sky" Program.

b. Lighting shall be hooded and directed downward to reflect away from adjoining properties.

c. Lighting shall be confined to the lot boundaries and not be oriented towards neighboring properties to protect privacy.

d. Pedestrian-scaled street lighting shall be provided within the proposed park areas pedestrian routes of travel to enable visibility and safety.

**xiv. Energy Efficiency**

To reduce wasteful and unnecessary energy consumption in newly constructed and existing buildings, all new construction of, and additions and alterations to, residential and nonresidential buildings within the Plan area shall comply with the state's Building Energy Efficiency Standards – Title 24.

**xv. Swimming Pool**

Swimming pools and/or similar recreational facilities shall comply with the requirements and procedures found within Section 17.20.065, Swimming Pools, of the SMMC.

**xvi. Signage Regulations**

Entry monuments that do not exceed 16 square feet and six (6) feet in total height shall not require a sign permit. All other signage within the Plan area shall comply with the design requirements and procedures found within Chapter 17.72, Signs, of the SMMC. A Signage Plan is required to be reviewed and approved by the City of Sierra Madre Planning and Community Development Department. Signage plan shall include both temporary, construction, and permanent signage standards and guidelines.





Total Number of Lots = 42.

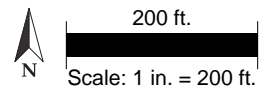

- 1-STORY
- 2-STORY
- PORCH

Note: Site plan is for illustrative purposes only and is subject to change.

**Figure 3-13: Conceptual Site Plan**

# 4 Infrastructure and Public Services Plan

## 4.1 Introduction

This chapter addresses the Specific Plan's infrastructure development plans for grading, drainage and water quality, water service, wastewater service, and dry utilities. The Specific Plan's EIR also addresses this infrastructure and includes additional requirements to help ensure that the infrastructure and public services can support the community envisioned by the Specific Plan.

The infrastructure/improvement plans presented in this chapter describe the extent and general description and layout of the proposed infrastructure and associated improvements, and the designs intended to establish the standards which the final plans must conform to. However, the plans presented in this chapter are preliminary and are subject to change. Detailed engineering designs, consistent with the design standards established in this chapter, will be prepared, reviewed, and approved by the City as part of the final construction or grading plans.

## 4.2 Conceptual Grading Plan

### 4.2.1 Existing Conditions

The Meadows at Bailey Canyon development is located on approximately 17 acres of an approximately 44-acre site. The approximately 17-acre Plan area is undeveloped and irregularly shaped, and the topography is sloped with a downhill grade generally in the north to south direction. Elevations on the Plan area range from a high of approximately 1,107 feet above sea level at the northwestern

portion of the site, to a low of 1,110 feet above sea level in the southeastern portion of the site, as shown on **Figure 4-1, Existing Topography**.

### 4.2.2 Proposed Conditions

Topography will be altered within the plan area to form four tiers (three tiers of housing and one tier for the park) with a slope between each tier, see **Figure 4-2, Grading and Wall**, and **Figure 4-3, Conceptual Site Section** (see **Chapter 3** for Wall and Fence Plan details). The existing gate on North Sunnyside Avenue, on the southern perimeter of the Plan area, will be removed and public access to North Sunnyside Avenue will be extended north, creating a maximum slope of 12% and an elevation range of approximately 1,200 feet above sea level in the north to 1,110 feet above sea level at the south end. On the southeast corner of the Plan area, the existing gate on Carter Avenue will be removed, and public access to Carter Avenue will be extended north of its existing public terminus along the eastern boundary to provide public, internal circulation within the Plan area, including access to the neighborhood park's parking lot. Carter Avenue will also provide a secondary access route to and from the Plan area to the existing Carter Avenue, creating a maximum slope of 12% and an elevation range of approximately 1,190 feet above sea level in the north to 1,105 feet above sea level at the south end.

As fully discussed in **Chapter 3**, the existing segment of Carter Avenue outside of the Plan area boundaries that will





Figure 4-1: Existing Topography



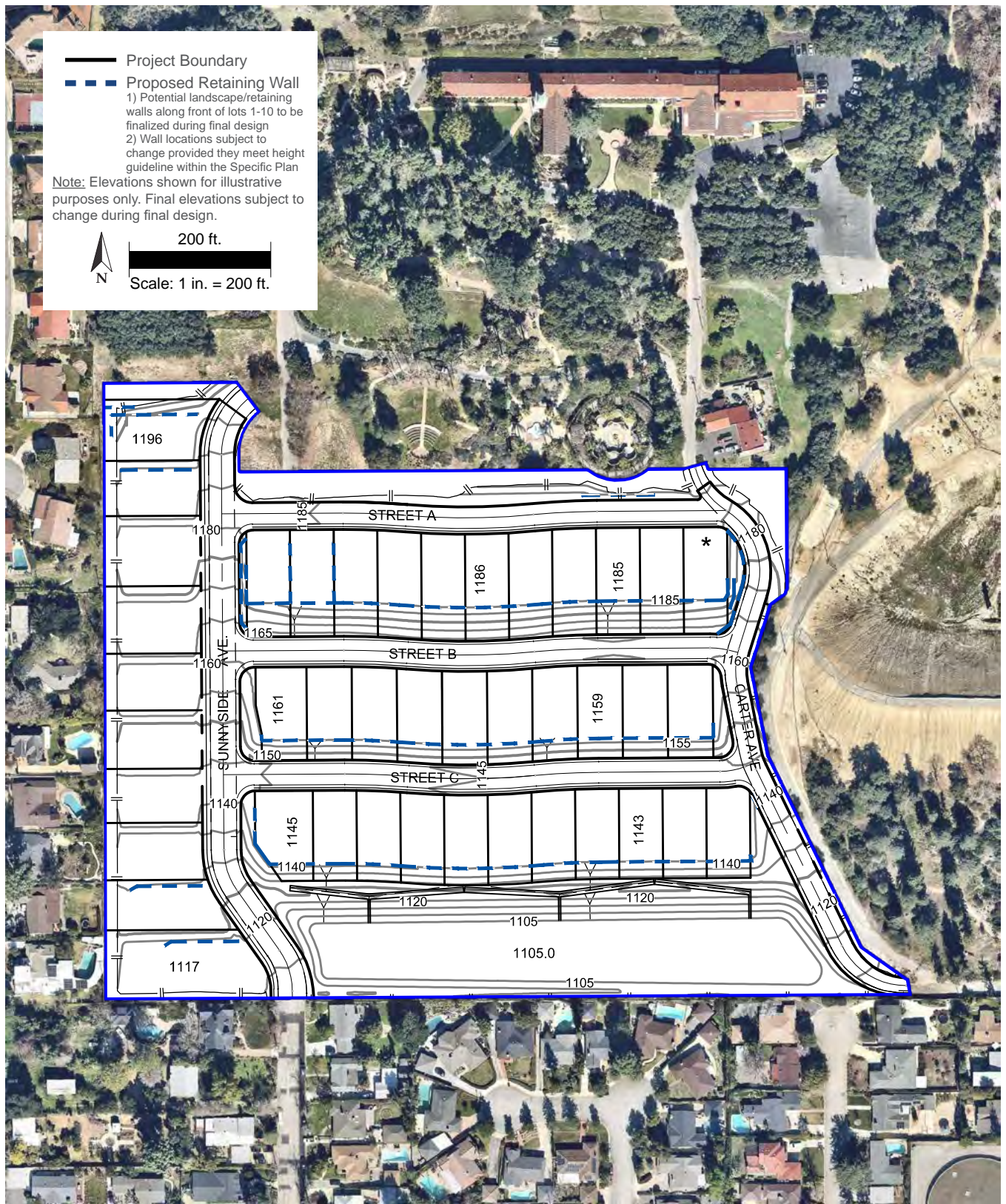

Figure 4-2: Graded Topography

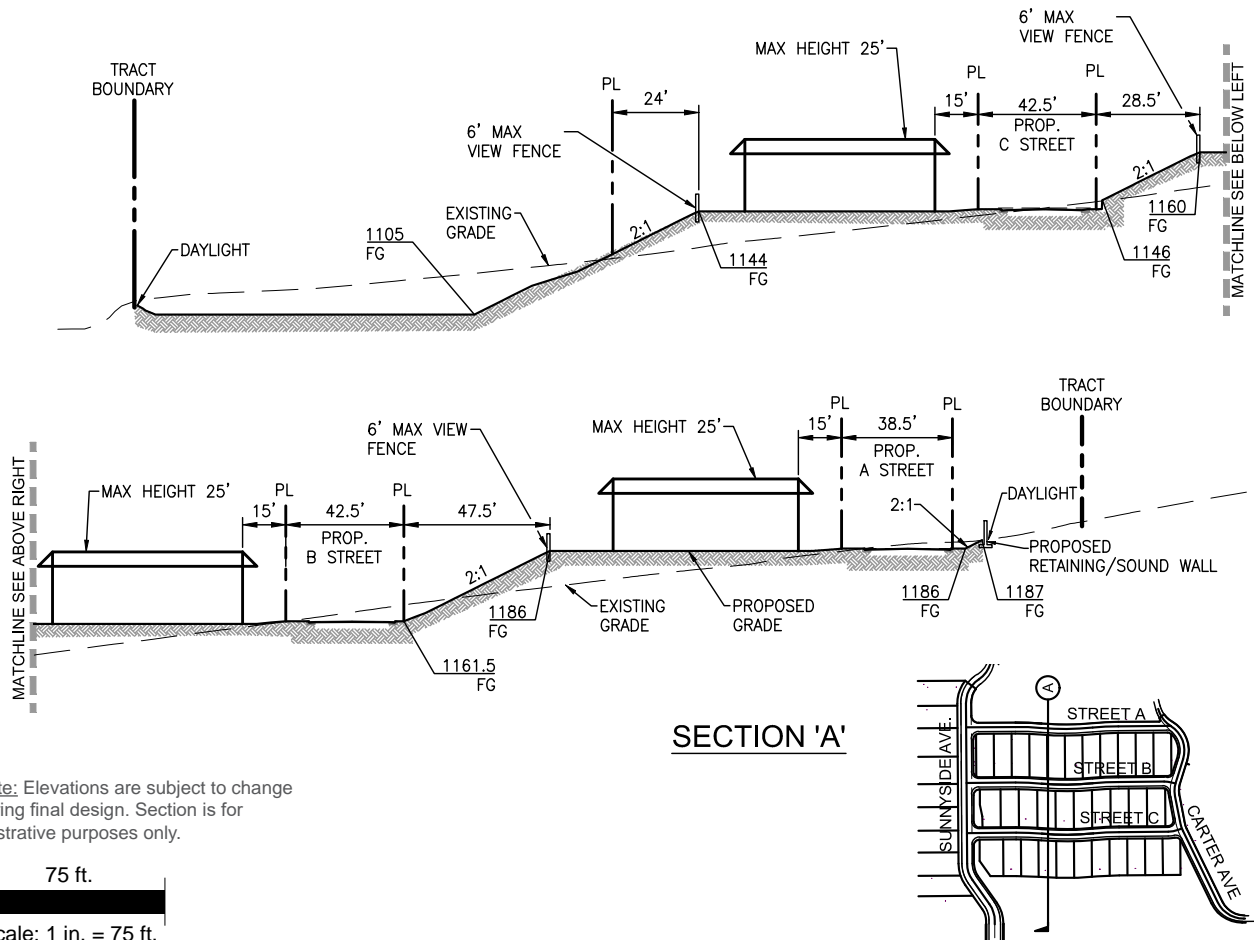

Figure 4-3: Conceptual Site Section

provide access into the Plan area will be widened as part of the proposed off-site improvements between the southeastern portion of the Plan area boundary and Oak Crest Drive (refer to **Appendix 3B, Offsite Improvement Plan**).

Along the northern boundary, Street A (approximately 670 linear feet of road beginning at North Sunnyside Avenue and ending at Carter Avenue) will be created with road elevations of approximately 1,185 feet above sea level. Street B (approximately 715 linear feet of road beginning at North Sunnyside Avenue and ending at Carter Avenue) will be created with road elevations of approximately

1,161 feet above sea level. Street C (approximately 720 linear feet of road beginning at North Sunnyside Avenue and ending at Carter Avenue) will be created with road elevations of approximately 1,145 feet above sea level. The approximately three-acre park will be created along the southern boundary of the Plan area at an elevation of approximately 1,105 feet above sea level.

### 4.3 Drainage/Water Quality

The Specific Plan incorporates methodologies to meet or exceed the ongoing National Pollutant Discharge Elimination System Permit



requirements. The Specific Plan includes a comprehensive series of drainage, flood control, and water quality improvements designed to allow for a system to both protect development and preserve downstream receiving waters from the Plan area.

### 4.3.1 Existing Conditions

The Plan area is located within the Los Angeles River watershed, which falls under the regulatory authority of the Los Angeles Regional Water Quality Control Board for the protection of surface water and groundwater quality. Runoff from the Plan area flows to the receiving waters of Arcadia Wash, which feed the Rio Hondo tributary of the Los Angeles River and ultimately discharge to the Los Angeles River Estuary and the Pacific Ocean, see **Figure 4-4, Regional Drainage**.

The Plan area, shown in **Figure 4-5, Existing Drainage**, includes an existing Los Angeles County Flood Control District 36-inch reinforced concrete pipe (RCP) storm drain that runs east to west from the adjacent private properties west of the Plan Area into the Plan area and then north to south under a portion of the existing private roadway north of North Sunnyside Avenue. This existing storm drain collects storm water from an existing debris basin northwest of the Plan area and eventually discharges into Arcadia Wash. The Plan area is separated into two major drainage areas, A and B, which comprise four sub-drainage areas, A-1, A-2, B-2, and B-3. These drainage areas drain via sheet flow, natural concentrated flow, and street flow to the municipal separate storm sewer system (MS4). The Plan area's existing drainage area is divided into the following sub-drainage areas:

- **Drainage Area A-1** (approximately 1.2 acre) consists of natural land cover and partially impervious roadway. This drainage area drains to two existing catch basins that feed two 21-inch RCPs located on either side of North Sunnyside Avenue. These two 21-inch pipes join the existing 36-inch storm drain and are conveyed offsite to Arcadia Wash.
- **Drainage Area A-2** (approximately 5.2 acres) consists of natural land cover and impervious roadway. Runoff from this area flows to an existing 24-inch RCP that connects into the existing 36-inch storm drain at the southern project boundary's edge. Flows converge with runoff generated from Drainage Area A-1 and are conveyed to Arcadia Wash.
- **Drainage Areas B-2 and B-3** (approximately 11.0 acres) consist of natural land cover and impervious roadway. Runoff flows in a southeastern direction where it discharges to Crestvale Drive via a 24-inch, above ground culvert.

### 4.3.2 Proposed Conditions

The Specific Plan proposes the creation of two independent storm drain networks that convey site runoff to the MS4, shown on **Figure 4-6a, Proposed Drainage**. The western storm drain network conveys runoff from Drainage Area 5A, while the eastern storm drain network services Drainage Area B2 and Drainage Area B3. On-site storm water flow will be captured and treated as detailed below.

The first storm drain network is located on the western portion of the Plan area and incorporates the existing 36-inch pipe with newly constructed storm drain conveyances. Portions of the existing 36-inch pipe will be removed





Figure 4-4: Regional Drainage



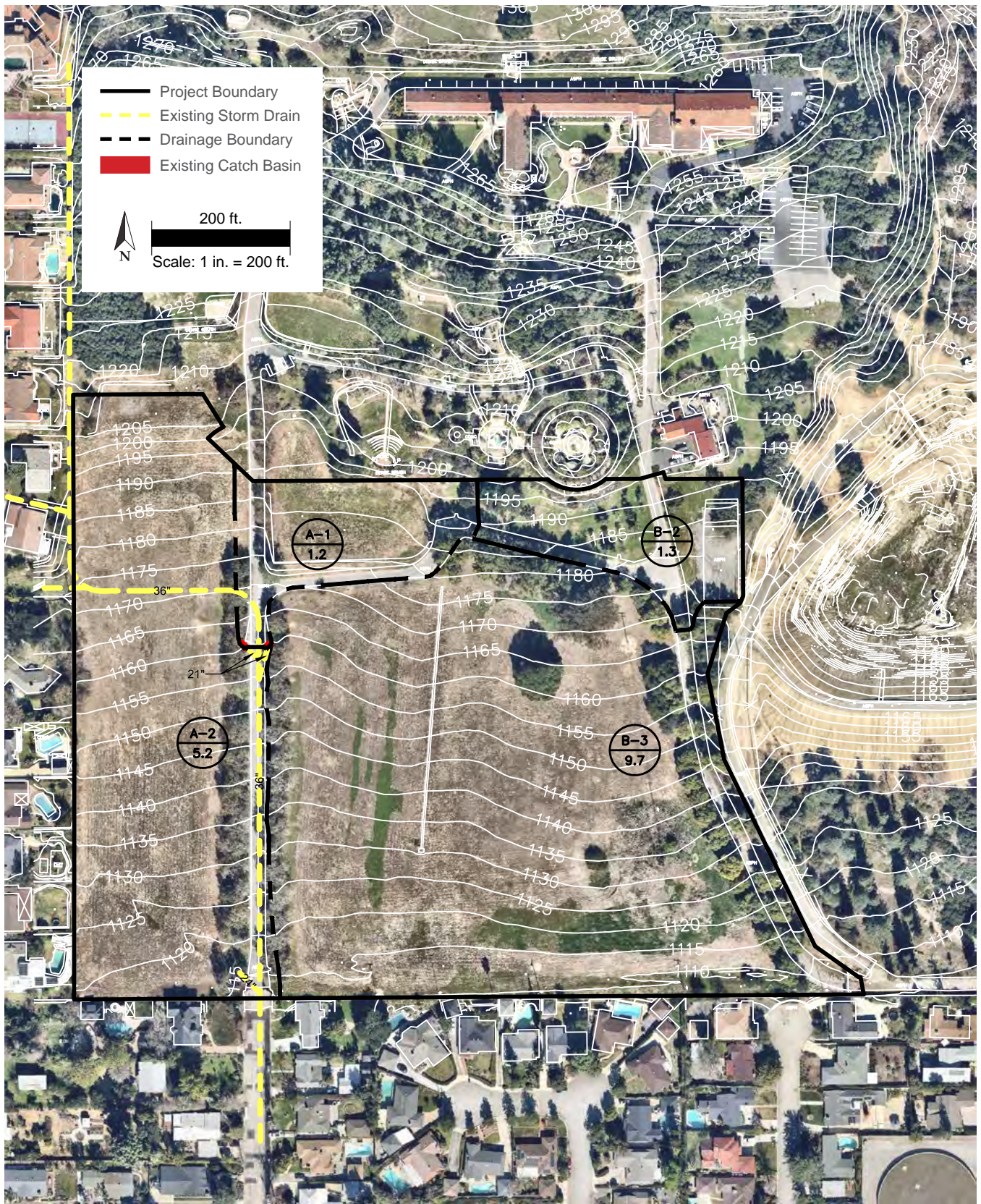

Figure 4-5: Existing Drainage



and reconstructed under the realigned extension of North Sunnyside Avenue and will connect with a proposed 36-inch RCP at North Sunnyside Avenue between Street A and Street B. Additionally, two proposed 18-inch RCP lateral connections will be added at the southern end of the Plan area. The proposed network will run north to south. Two on-site catch basins are proposed to capture runoff generated from approximately 5.3 acres of the Plan area (Drainage Area 5A in **Figure 4-6a**). In addition, just north of the Plan area boundary, two offsite catch basins will capture offsite flows before runoff enters the Plan area via the North Sunnyside Avenue extension. The western storm drain network ties in with an existing 36-inch storm drain in North Sunnyside Avenue at the southwest side of the Plan area and ultimately conveys runoff to Arcadia Wash.

The second storm drain network is located on the eastern portion of the Plan area. The network is made up of 18-inch and 24-inch RCPs and has a contributing area of approximately 8.6 acres (Drainage Area B2 in **Figure 4-6a**). Streets A, B, and C each have two catch basins, which capture and convey surface runoff to the east via proposed 18-inch RCPs to a proposed 24-inch RCP under the future extension of Carter Avenue. This 24-inch storm drain runs north to south along the majority of the proposed extension of Carter Avenue and also conveys surface runoff captured by two catch basins located offsite on the existing Retreat Center parcels at the north end of the future Carter Avenue extension just north of the Plan area boundary. The eastern storm drain network also includes a proposed 24-inch RCP located in the southeastern portion of the Plan area. This 24-inch storm drain run east to west to convey surface runoff from two proposed catch basins located on either side of the south end of the Carter Avenue extension. Both proposed 24-inch RCPs in the eastern storm drain network discharge to a

proposed underground retention storage gallery in the southern portion of the Plan area shown on **Figure 4-6b**.

The southern portion of the Plan area is to be developed into park space with a drainage area of approximately 3.4 acres (see Drainage Area B3 in **Figure 4-6a**). Runoff generated from this area drains via sheet flow and natural concentrated flow to the southeastern portion of the Plan area and discharges to Crestvale Drive via a 24-inch surface culvert. Portions of the approximately three-acre park will be depressed to promote additional above ground storage and infiltration. Runoff that is not retained and treated on-site will be conveyed to the southeast corner of the park and exit to Crestvale Drive via 24-inch surface culvert and to the MS4 downstream to Arcadia Wash.

The retention storage gallery shown on **Figure 4-6b, Proposed Park Detention Basin**, is designed to provide an approximately 129,100-cubic foot (cf) storage facility to help clean and detain on-site stormwater runoff. The retention gallery's underground storage gallery will consist of approximately 3,500 linear feet of 60-inch diameter perforated pipe surrounded by a gravel bed for an underground storage volume of approximately 97,600-cf. This retention storage gallery will be approximately 24 inches below ground and will promote water quality treatment through infiltration. Additionally, a 1-foot deep above ground storage area will provide an additional approximately 31,490-cf of above ground storage for a total retention volume of approximately 129,100-cf in the park's retention system. Based on the proposed volume for the park's retention system, the storage gallery's capacity exceeds the required retention volume needed to retain and treat the 50-year retention volume for the Crestvale Drainage Area.



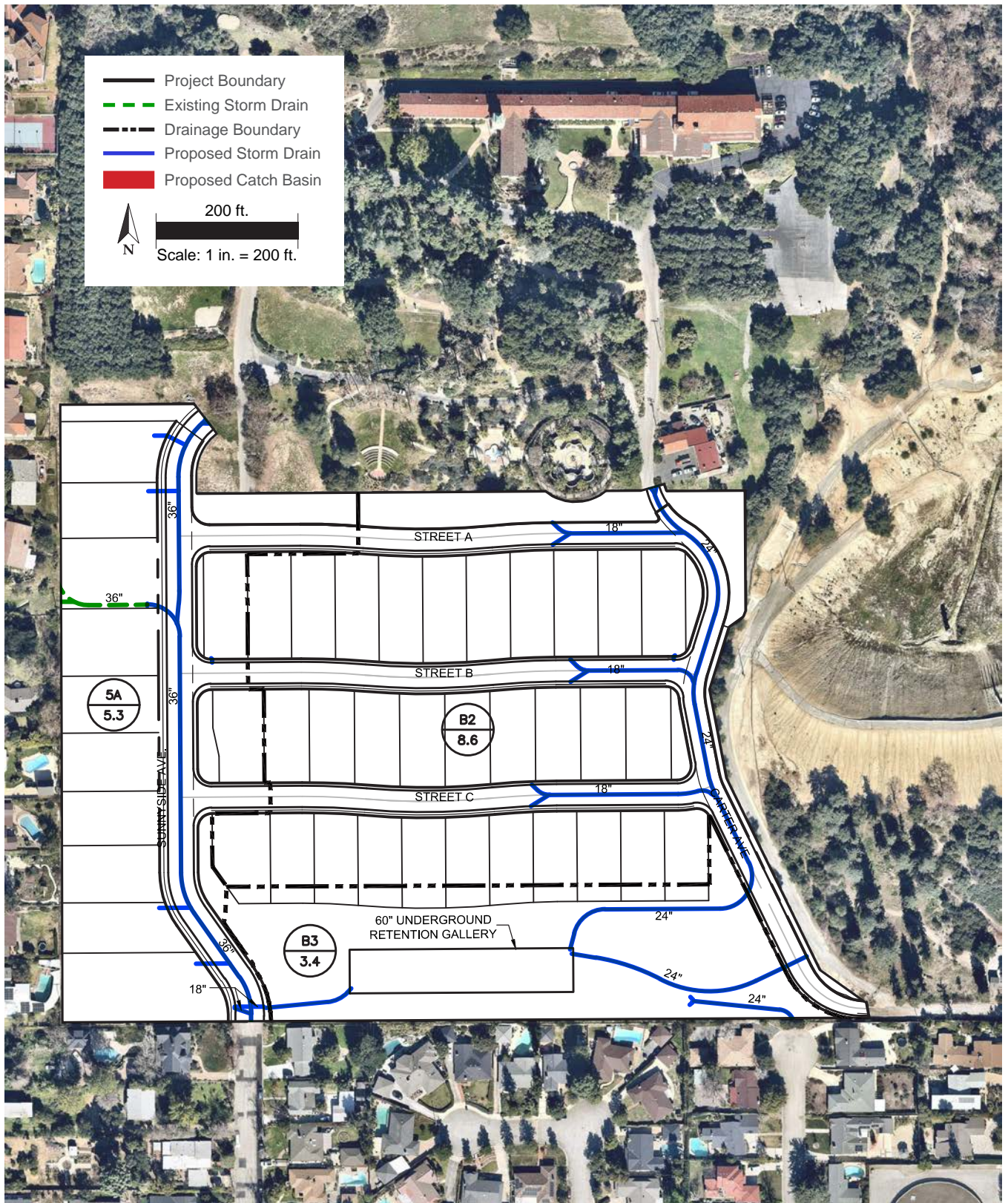
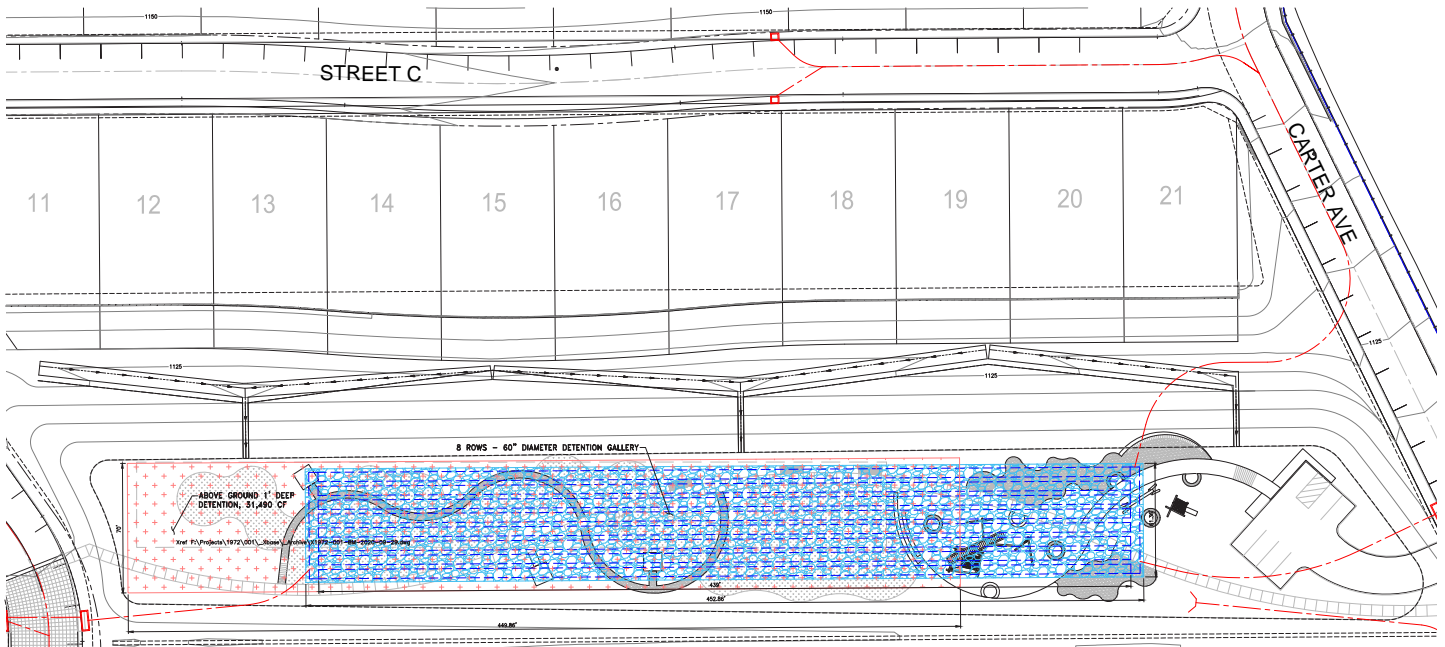

Figure 4-6a: Proposed Drainage



Required 50-year retention volume for Crestvale Drainage Area = 128,880

**Detention Basin**

8 Rows of 60" Retention Pipes at 439 LF = 97,634 CF

Above Ground Storage = 31,490

Total Retention Volume = 129,124 CF

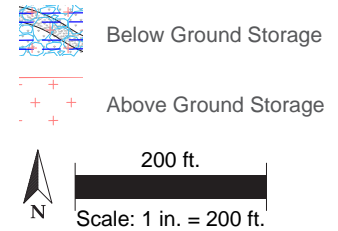

**Figure 4-6b:** Proposed Park Detention Basin



Final plans approved by the City for the retention and stormwater treatment facility located within the public park shall be designed to ensure that the retention gallery has the adequate capacity to retain a volume of water greater than or equal to all onsite stormwater runoff in a 50-year capital storm event.

Secondary Emergency or stormwater above the 50-year capital storm event not captured by the retention infiltration gallery will exit to Crestvale Drive and North Sunnyside Avenue. Final drainage plans to be approved by the City as part of the final construction or grading plans, will ensure that stormwater retention is designed to meet, or exceed, the City's Low Impact Development (LID) plan requirements for 85th percentile in a 24-hour storm event, found within Section 15.58.080, LID plan requirement, of the SMMC. and that onsite detention is designed to retain the capital 50-year storm event, Q50.

## 4.4 Water Service

### 4.4.1 Existing Conditions

The Plan area is currently undeveloped; as such, the site is not served by water facilities. Within the Plan area, an existing 8-inch water line along Carter Avenue connects the existing Retreat Center (north of the Plan area) to the existing water line in Carter Avenue at the southeast corner of the Plan area. Another off-site existing water line is located in North Sunnyside Avenue near the existing Retreat Center gate on the southern boundary of the Plan area.

### 4.4.2 Proposed Conditions

Outdoor water use estimates were calculated for the Specific Plan's development using the maximum applied water allowance<sup>1</sup>. Based on these estimates, the maximum allowable outdoor water use would be approximately 18 acre-feet per year (AFY) for the public park and HOA maintained open space. In addition, based on detailed water demand estimates prepared for the Specific Plan, the Meadows at Bailey Canyon development will generate a total potable water demand of approximately 8.26 AFY of indoor water use. The potable water demand will be met by the City, through a combination of local groundwater from wells located primarily in the Raymond Groundwater Basin and imported water delivered by the San Gabriel Valley Municipal Water District. The amount delivered from each source varies due to hydrologic and other conditions.

Based on the maximum allowed outdoor water use and indoor water use estimates, the Specific Plan's development will generate an estimated total demand of approximately 26.30 AFY. Although the Sierra Madre Water Department would have sufficient available supply to meet the estimated total water demand associated with the proposed development, development within the Plan area will comply with energy and water efficiency standards, and water efficient landscaping requirements outlined in **Chapter 3**. Therefore, the anticipated water demand, outlined above, represents the maximum amount of water usage estimated by the Specific Plan's development.

<sup>1</sup> The Maximum Applied Water Allowance (MAWA) is the maximum annual gallons per year of water allowed for a landscape area in accordance with the landscaping requirements set forth in Chapter 3 of this Specific Plan and the City's Water Efficient Landscape Ordinance (WELo) set forth in Chapter 15.60 of the SMMC.



Final anticipated total indoor and outdoor water demand estimates will be determined upon approval of construction documents for the Plan area.

In addition, the Plan area will achieve a net zero impact on local water supplies through one of the following:

- **Pre-purchase of supplemental water** from the San Gabriel Valley Municipal Water District (SGVMWD) on behalf of the City in an amount equal to the anticipated total indoor and outdoor water demand of each residential unit over a 50-year period (i.e. the expected life of the homes). This purchase would be in addition to the City's existing agreement with SGVMWD providing for the purchase of supplemental imported water. The supplemental water purchase will be based on the final design and associated usage calculations.
- **Creation of a lawn retrofit program**, which would provide homeowners with a grant provided to replace their lawn with turf.
- **Improvements to existing water infrastructure**, such as pipe leakage fixes.

**Figure 4-7, Existing and Proposed Water System**, depicts the on-site potable water system to serve the Plan area. As shown on **Figure 4-7**, the potable water delivery system consists of a network of water mainlines to be located within the planned roadways. The existing 8-inch water main in the eastern portion of the Plan area will be removed and reconstructed as a 12-inch water main in the planned extension of Carter Avenue. Water mains within the other planned roadways (North Sunnyside Avenue extension and A, B and C Streets) will all be 8-inch

diameter water mains. The proposed water mainlines will distribute the potable water for connection to laterals located on individual lots. Potable water storage will be provided by the City's infrastructure system. The proposed water mainlines will join the existing water mainlines at North Sunnyside Avenue and Carter Avenue at Lima Street, and will tie into the Oak Crest transmission main.

The approximately three-acre park will have its irrigation water supplied by the City and be maintained by the Landscape Maintenance District, or similar public maintenance district.

## 4.5 Wastewater Service

### 4.5.1 Existing Conditions

The Plan area is undeveloped and will require wastewater infrastructure to serve the site. Within the Plan area, an existing 6-inch private sewer line north of Crestvale Drive parallel to Carter Avenue connects the Retreat Center (north of the Plan area) to the existing 8-inch sewer line in Crestvale Drive. A second existing 8-inch sewer line is located in North Sunnyside Ave at the southwest corner of the Plan area.

### 4.5.2 Proposed Conditions

Based on detailed water demand estimates prepared for the Specific Plan, the Meadows at Bailey Canyon will generate a total sewage load of 5.21 gallons per minute. The City will collect all sewage from the Meadows at Bailey Canyon into its existing 8-inch sewer lines in North Sunnyside Avenue and Crestvale Drive. The Los Angeles County Sanitation District will treat the wastewater generated by the Meadows at Bailey Canyon development.

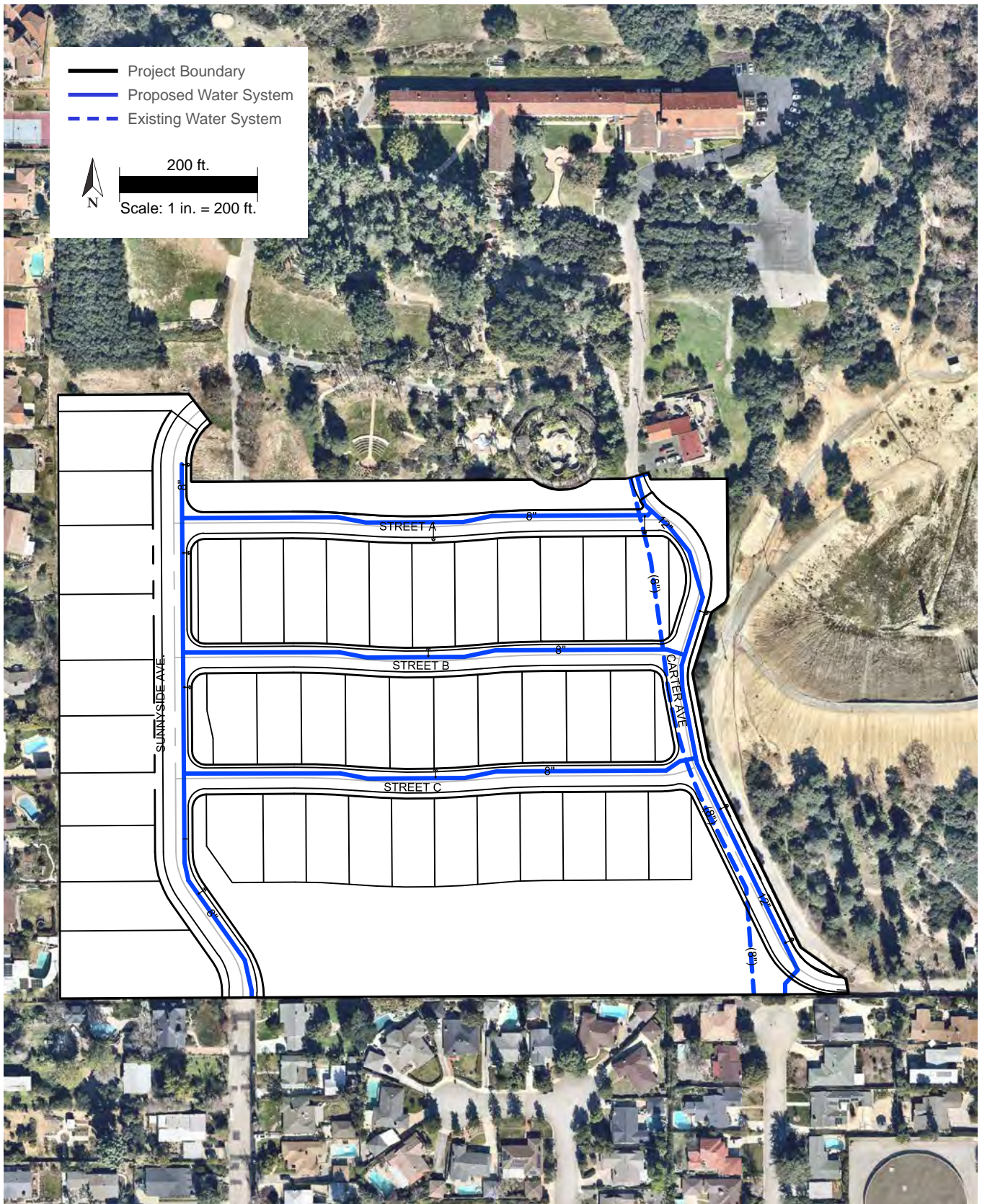

Figure 4-7: Existing and Proposed Water System





Figure 4-8: Existing and Proposed Wastewater System



**Figure 4-8, Existing and Proposed Wastewater System**, depicts the on-site sewer system to serve the Plan area. As shown on **Figure 4-8**, the sewer system consists of a network of 8-inch sewer mainlines that are within the planned roadways. The proposed sewer mainlines collect the sewage from laterals located on individual lots and outlet into the existing public 8t-inch sewer mains in North Sunnyside Avenue and Crestvale Drive. The existing Retreat Center sewer line on the Plan area will be relocated into the planned extension of Carter Avenue. The existing 8-inch sewer lines at the southwest corner of the Plan area will be removed.

## 4.6 Dry Utilities

### 4.6.1 Existing Conditions

The Plan area is undeveloped and will require electric, natural gas, and telecommunication infrastructure to serve the Meadows at Bailey Canyon development. The Retreat Center is served by the following existing dry utilities:

- Southern California Edison (SCE) electricity line in between the north ends of Sierra Keys Drive and Crestvale Drive
- A Spectrum cable that runs from the backyards of existing homes on the north and east sides of Sierra Keys Drive up Carter Avenue to the Retreat Center
- A Frontier cable that runs from the existing gate at the west end of West Carter Avenue up Carter Avenue to the Retreat Center
- A Southern California Gas Company natural gas pipeline that is metered at the existing gate at the west end of West Carter Avenue

There is also an existing off-site Southern California Gas Company natural gas line in North Sunnyside Avenue near the existing gate at the southern boundary of the Plan area.

### 4.6.2 Proposed Conditions

Electric, telecommunication, and natural gas infrastructure will be installed to serve the Plan area, as shown in **Figure 4-9 Proposed Dry Utilities**. All newly construct dry utilities within the Plan area shall be undergrounded. These "dry" utilities will be located within underground conduits in the public street corridors/rights-of-way. Prior to and during the final infrastructure/improvement plan stages, consultation with all appropriate utilities will be required to determine the extent of the dry utilities needed to serve the Plan area.

For electricity service, the Plan area is located within the Southern California Edison service area. The existing electricity line in between the north ends of Sierra Keys Drive and Crestvale Drive will be extended to service the Plan area. New electricity lines will be constructed underground throughout the Plan area. The existing above-ground SCE electricity line serving the Retreat Center will remain above ground.

Telecommunications service will be provided by Frontier or Spectrum. Telecommunications service will come from the existing phone service line in between the north ends of Sierra Keys Drive and Crestvale Drive. Telecommunication lines will be constructed underground throughout the Plan area.

For natural gas service, the Plan area is within the Southern California Gas Company service area. Natural gas service will come from the existing off-site

FOR EXHIBIT  
PURPOSES ONLY

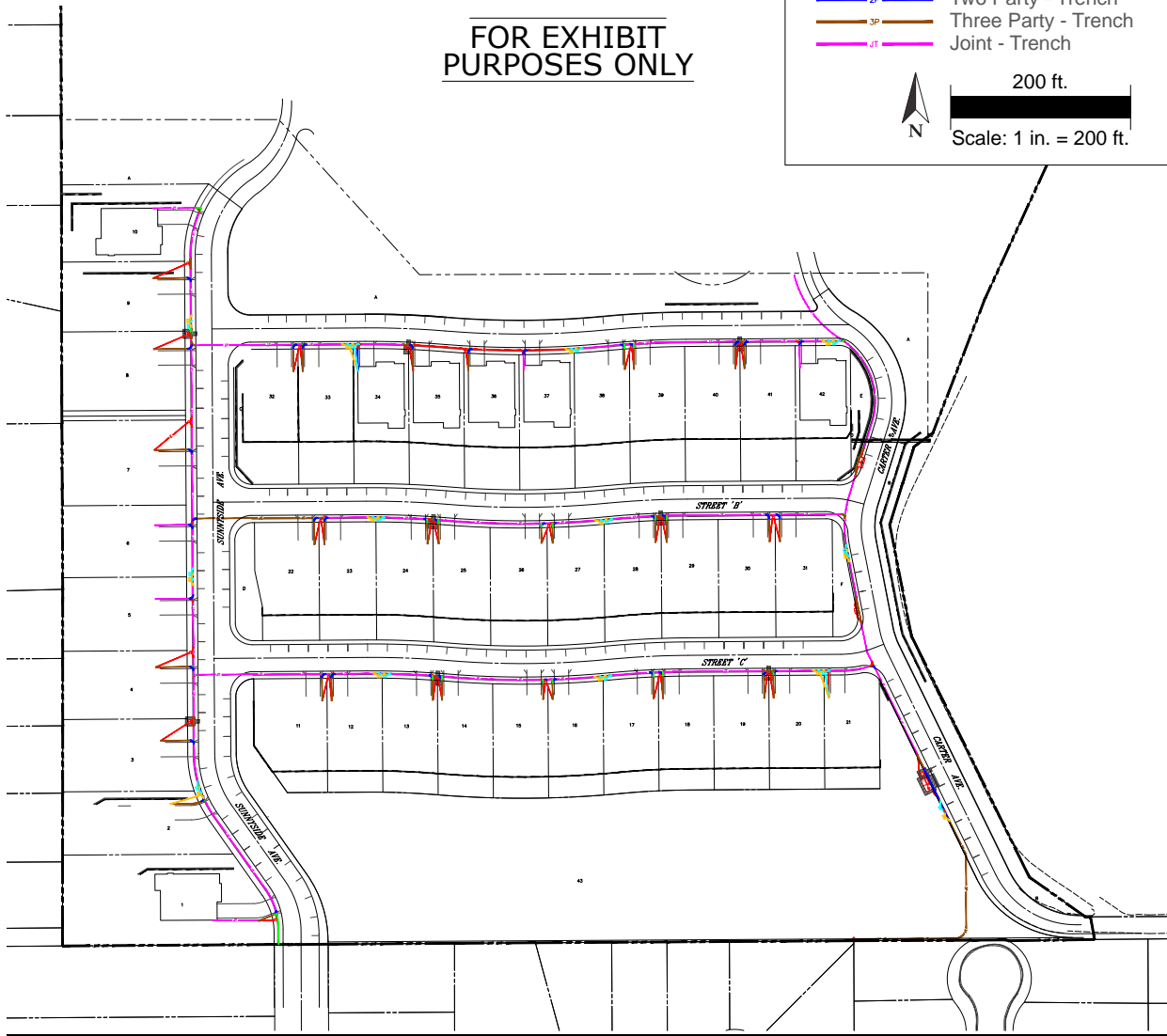
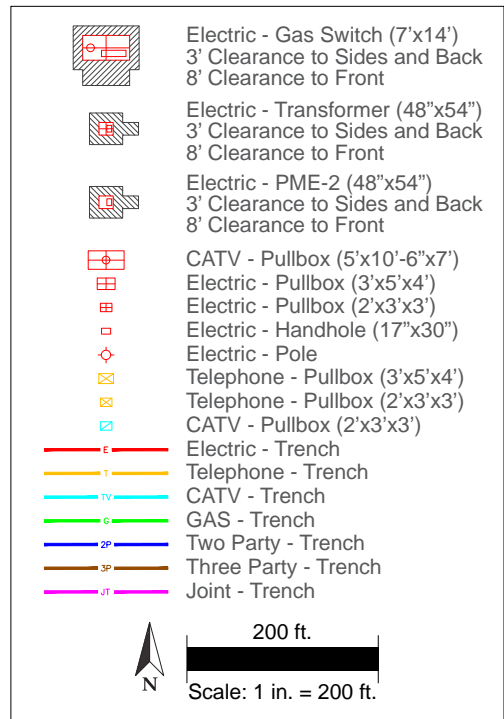

Figure 4-9: Proposed Dry Utilities



natural gas service line located on North Sunnyside Avenue near the existing gate at the southern boundary of the Plan area. Natural gas lines will be constructed underground throughout the Plan area.

## **4.7 Public Services**

### **4.7.1 Fire**

Sierra Madre Fire Department (SMFD) currently serves the Plan area and the surrounding area. SMFD is responsible for emergency medical calls, fire response, inspection, and plan check services. The frequency of emergency response calls is expected to increase in the Plan area relative to existing conditions. However, due to the relatively low population growth expected from the development and because this growth falls well within the projected population growth for the City, the expected population growth is not considered substantial and has been accounted for in local and regional population projections. In addition, SMFD has reviewed the development and has determined that it would not have a significant effect on service demands.

### **4.7.2 Police**

The Sierra Madre Police Department (SMPD) provides police protection services to the City. The SMPD station is located at 242 West Sierra Madre Boulevard, approximately 0.7 miles southeast of the Plan area. The SMPD station performs various law enforcement, code enforcement, traffic enforcement, investigative functions, and various administrative duties. SMPD also participates in a mutual-aid agreement with the local surrounding cities of Pasadena, Arcadia, and Monrovia<sup>2</sup>.

According to the General Plan EIR, the City does not utilize an officer-to-resident population ratio to measure adequacy of service. However, in response to a public services information request, the SMPD stated that the development would affect response times and service ratios under existing staff and facility conditions. Under existing conditions, the average response time to the project site would be approximately two minutes and there are no existing plans to increase facilities or equipment<sup>3</sup>. Payment of development fees by the project applicant, as required by the Sierra Madre Public Facilities Fee Ordinance, in Chapter 15.52 of the SMMC, would be used to offset the costs of increased personnel or equipment that could be required in order to maintain acceptable service ratios, response times, and other performance objectives. Therefore, the SMPD would adequately serve the Plan area.

### **4.7.3 Emergency Medical Technicians (EMT)**

The SMFD personnel operates in conjunction with the City's Emergency Medical Services. See **Section 4.7.1, Fire** for additional information.

### **4.7.4 Schools**

The Plan area is served by the Pasadena Unified School District (PUSD). Schools serving the Plan area include Sierra Madre Elementary School (grades K-5), Sierra Madre Middle School (grades 6-8), and Pasadena High School (grades 9-12). The schools serving the Plan area are projected

1 City of Sierra Madre 2015a; City of Sierra Madre 2002b.

2 City of Sierra Madre 2020b.

to have a surplus capacity of approximately 1,199 seats in the future (56 seats for grades K–5, 240 seats for grades 6–8, and 903 seats for grades 9–12). Therefore, the schools' anticipated availability in capacity is expected to accommodate the Plan area.

#### **4.7.5 Library**

Library services are provided at the Sierra Madre Public Library. Due to the minor increase in service population expected from the Plan area, the increase in residents would not substantially impact library facilities. In addition, payment of development fees would be used to offset the costs of increased personnel or equipment that could be required to maintain such services. Therefore, the Plan area is expected to be accommodated through existing library services.

# 5 Design Standards and Guidelines

## 5.1 Purpose and Intent

The purpose of the Specific Plan's Design Standards and Guidelines is to provide guidance in the site planning, architecture, and landscape design for residential development in the Plan area. The Design Standards and Guidelines uphold the Vision and Guiding Principles by describing the City's desired visual, aesthetic, and stylistic character of residential development in the Plan area to produce a consistent and cohesive level of quality in design.

## 5.2 Relationship to Development Standards

The Development Standards set forth in **Chapter 3** outline various **objective** and **quantifiable** required development standards, such as heights requirements, setbacks, and parking, for example.

The Design Standards and Guidelines set forth in this chapter serve to provide **aesthetic** guidelines for the implementation of the Development Standards requirements by describing aesthetic and **qualitative** features in the site, building, and landscape design, such as architectural style and building elements, for example.

Although the Design Standards and Guidelines describe overall qualitative direction of select design features, the difference between Standards and Guidelines should be noted:

- **Design Standards** are expressed by the word “shall” to describe mandatory requirements. Although non-quantifiable (e.g., not described by a number, such as a quantity, dimension, or size, etc.), the Design Standards address qualitative design conditions that are deemed necessary in upholding the Vision and Guiding Principles.
- **Design Guidelines** are expressed by the word “should” to describe recommendations that are encouraged where feasible, but are not mandatory. Although non-quantifiable, the Design Guidelines address qualitative design conditions based on best design practices.

The Design Standards and Design Guidelines are not intended to hinder flexibility or stifle creativity. Instead, they establish basic evaluation criteria for City review of projects during the City's Design Review process. Refer to **Chapter 6** for more information on implementation.

## 5.3 Use of Diagrams and Photographs

Diagrams, photographs, and adjoining captions are used in this chapter to illustrate the intent behind a noted Design Standard or Guideline. Diagrams illustrate general hypothetical conditions, while photographs illustrate real-world examples of development projects. Some diagrams and photographs are used to illustrate how a particular design feature complies



with the Design Standards and Guidelines, while others are used to illustrate how a design feature does not comply and are therefore not encouraged. The inclusion of a photograph of a certain development project does not mean that a similar project will meet the Design Standards and Guidelines, nor does it mean that the development project shown in the photograph is an exemplary project.

## 5.4 Site Planning and Design

### 5.4.1 Building placement, orientation, and street-facing facades

- a. Refer to **Chapter 3** for requirements on building heights and setbacks, and **Chapter 4** for requirements on grading, all of which affect building placement and orientation on site.
- b. To enhance curb appeal and foster a pedestrian-friendly street, buildings shall orient to and have a visual connection with the street, by facing primary facades, door entries, windows, porticos, and porches visibly to the street.
- c. Buildings should be oriented to provide adequate light and air while protecting the privacy of adjacent neighbors.

### 5.4.2 Driveways and Garages

- a. Avoid private entry gates, fences, or doors at driveways for attached garages.
- b. Garages shall not be the dominant architectural element facing the street. Instead, garages shall be set back from the main building.
- c. Garage doors should be inset from the garage façade.

- d. Garage door recesses should be at a minimum of 12 inches.
- e. If used for detached garages, porte-cocheres should be architecturally consistent with and integrated into the main building.
- f. Driveways should respond to the topography and minimize excessive areas of grading and paving.
- g. Driveways shall not have private entry gates.



**Appropriate:** Building is oriented to and has visual connection with the street.

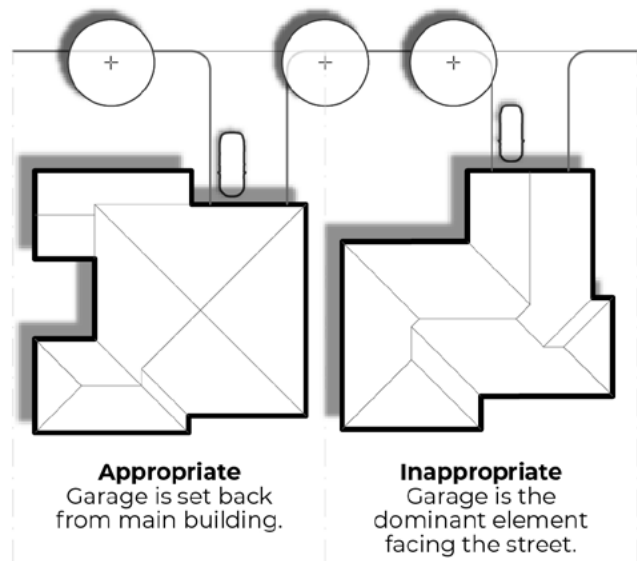

**Figure 5-1:** Attached garages should be set back from the main building.

### 5.4.3 Public realm

- a. Refer to **Chapter 3** for requirements on exterior lighting, landscaping, and pedestrian pathways, all of which affect the design of the public realm.

## 5.5 Architectural Design

### 5.5.1 Architectural styles and character

- a. The Plan area should be composed of a diversity of design, styles, and character.
- b. To ensure a harmonious integration and compatibility with the adjacent Sierra Madre community, while enabling a diversity of styles and eclecticism, the design of all buildings, inclusive of materials, elements, and details on a single lot shall be stylistically consistent with one of the following architectural styles. See **Appendix 5A, Architectural Styles Reference Guide** for a reference guide on each recommended architectural style and associated design features.
  - i. Contemporary Craftsman
  - ii. Spanish Colonial Revival
  - iii. Modern
  - iv. Contemporary Farmhouse
- c. A combination of different architectural styles on a single lot shall not be used.

### 5.5.2 Building mass, form, scale, and articulation

- a. Building mass, form, scale, and articulation shall be consistent with the selected architectural style.

- b. The same elevation in the same floor plan shall not be repeated on any given street, with the exception of Street "A." Refer to **Appendix 5B, Architectural Elevations**, for illustrative examples of floor plan elevations.
- c. Form, materials and type of ornamentation should be consistent on all four elevations on a building.
- d. Building details should be in proportion to the overall building massing. Oversized, monumental forms and elements that are disproportionate in scale to the overall building shall not be used (e.g., oversized entry columns which are disproportionate with the massing of the building façade). Overall building compositions should be balanced.
- e. Primary facades without articulation or fenestration shall not be used. Instead, buildings should consider the following strategies consistent with the selected architectural style, and shall incorporate at least three of the following strategies:
  - i. Second stories should be stepped back from the first.
  - ii. Transitions in height should be incorporated.
  - iii. Large volumes should be broken up into smaller ones.
  - iv. There should be variations in horizontal and vertical wall and roof planes.
  - v. Balconies, porticos, and porches should be incorporated.



**Appropriate:** Articulated primary facade by breaking up large volumes into smaller ones.



**Appropriate:** Articulated primary facade by stepping second stories back from the first.



**Appropriate:** Articulated primary facade by variations in horizontal and vertical wall and roof planes.

- f. Rear facades without articulation or fenestration shall not be used. The following strategies shall be used, consistent with the selected architectural style:
  - i. The same materials as used in the primary façade should be incorporated wherever possible.
  - ii. Large volumes should be broken up into smaller ones.
  - iii. There should be variations in horizontal and vertical wall planes.

### 5.5.3 Roofs

- a. Roof materials and elements (e.g., fascia, flashing, gutters, etc.) should be consistent with the selected architectural style and applied consistently on all roof forms.
- b. Roof components (e.g., materials, eave lines, dormers, fascia boards, etc.) should be applied consistently on all elevations, including those that are not visible from the public right-of-way.
- c. Roof forms should be varied and articulated through:
  - i. Changes in roof height.
  - ii. Changes in direction of roof slopes/pitches.
  - iii. Offsets.
  - iv. Use of roofs on lower levels as decks serving higher levels.
- d. A combination of lower and upper roof components and forms, appropriate to the architectural style, may be used to add interest and reinforce the separation of building masses.



## 5.5.4 Windows

- a. Window materials and elements (e.g., frames, hardware, shutters, awnings, etc.) should be proportioned to the window size, and consistent with the selected architectural style and applied consistently on all windows.
- b. The arrangement of windows on a façade and their proportions should be balanced and consistent with the selected architectural style.
- c. The size and location of windows should be related to the scale and proportion of the building elevation.
- d. The size, detailing, and arrangement of windows on elevations should be consistent with the selected architectural style.
- e. Non-rectangular, irregular window shapes shall not be used (e.g., circles, ellipses, and trapezoids), unless if consistent with the selected architectural style.
- f. Reflective glass or films (e.g., mirrored) shall not be used.
- g. Unfinished aluminum or other metal windows should not be used.
- h. Simulated divided lites to simulate true divided lites are acceptable. Authentic divided lites are not required.
- i. Windows shall be energy efficient, high-quality, and durable.
- j. Windows shall be designed and placed to maximize the use of natural daylight.
- k. Window, clerestories and dormers should be designed and located to maximize natural daylight and reduce reliance on electrical lighting.
- l. Placement, shape, and size of dormers windows should consider the scale and proportions of the primary building as well as interior spaces and functions.
- m. Large expanses of glass may be used when set within a structural frame. Deep roof overhangs are encouraged above large areas of glass to provide shade and minimize glare.
- n. Awnings should be consistent with the selected architectural design.



**Appropriate:** Primary door entry is visible, identifiable, and emphasized by use of a porch.



**Inappropriate:** Oversized, monumental primary door entry elements, e.g., two-story columns.



**Inappropriate:** Tubular, domed, or "bubble" skylights shall not be used.

### 5.5.5 Doors

- a. Door materials and elements (e.g., frames, hardware, etc.) should be consistent with the selected architectural style and applied consistently on all facades.
- b. Primary door entries shall be clearly visible and identifiable from the street and should be emphasized with special architectural and landscape treatments. For example, doors should consider following strategies:
  - i. Protected from climatic elements using porticos, porches, or roof overhangs.
  - ii. Decorative ornamentation, e.g., pediments, columns, sidelights, etc.
- c. The size and location of doors should be related to the scale and proportion of the building elevation. Oversized, monumental primary door entry elements that are disproportionate in scale to the overall building (e.g., two-story columns) shall not be used.
- d. The proportion of solid to open elements should be balanced on all wall planes. Oversized elements should be avoided.

### 5.5.6 Skylights, solar panels, and chimneys

- a. Skylight, solar panel, and chimney materials and elements shall be consistent with the selected architectural style and be fully integrated into the roof design, excepting solar panels which may be roof mounted.
- b. Solar panels should be oriented to the south to maximize efficiency and establish visual consistency across buildings.
- c. When installed on top of a residence, solar panels should be appropriately placed flat on the roof structure to minimize visibility from off-site
- d. Flashing, sheet metal, and framing should be colored to match the roof



**Appropriate:** Porches are consistent with the selected architectural style and integrated into the design of the building.



material, and exposed metal should be anodized, or factory finished to match surrounding roof materials.

- e. For skylights, employ the following strategies:
  - i. Glazing should be clear, flat, or non-reflective.
  - ii. Tubular, domed, or “bubble” skylights shall not be used.
  - iii. Skylights should be mounted on the same plan and angle as the roof.
  - iv. To eliminate skyward glare, interior lights should not be oriented upward through skylights.

- f. Changes in material should generally occur when there is a change in the plane of the façade. If possible, the change in material should occur on inside corners of the building. If a change is proposed along the line of a single plane, a pronounced expansion joint or trim piece should be used to define a clear separation. Stone should turn corners and not be used only on one wall of a facade.
- g. Building facades should not include the following materials: plywood, hardboard Masonite, unfinished lumber, aluminum siding, corrugated sheet metal or tin siding, textured T1-11 siding, plastics/ plastic laminates, highly reflective materials.

### 5.5.7 Exterior materials and colors

- a. Materials and colors should be consistent and complementary with the selected architectural style.
- b. Colors should be durable and not readily deteriorate with exposure to the elements.
- c. Materials should be durable and low maintenance, and able to withstand long-term exposure to elements.
- d. Materials and technologies that minimize environmental impacts, reduce energy and resource consumption, and promote long-lasting development should be used.
- e. Building materials used on a façade (excludes trim work and decorative elements) should be limited to no more than two different materials (excluding glass windows) on a single façade. Frequent changes in materials should be avoided.



**Appropriate:** Landscaping is complimentary and consistent with the architectural style.



- h. Color applications on a façade should generally be limited in number (e.g., one or two main colors and two to three accent colors that complement the main color(s) of the house).
- i. Colors should be non-reflective.
- j. Painted building surfaces should have a matte finish. Trim work may have a glossy finish.
- k. Green Seal certified products and/or other products with low levels of volatile organic compounds (VOCs) are encouraged on painted and stained surfaces.

### 5.5.8 Utilities and Equipment

- a. Mechanical equipment, including air-condition units, utility meters, pool/spa equipment and similar above-ground devices, should be screened from off-site views by the use of architectural devices and/or plant materials. Where feasible, these areas are to be integrated into the building’s architecture. Noise emission from such devices is to be contained.
- b. All utilities with exposed metal (meters, outlet covers, etc.) are to be painted to match adjacent natural and/or building materials.
- c. Gutters, scuppers and downspouts should be integrated into the exterior design and not “tacked on.” These items should be finished to blend in with the background material or be integrated into the architectural design.

### 5.5.9 Balconies, porticos, and porches

- a. Balcony, portico, and porch materials and elements (e.g., columns, railings, roof overhangs, etc.) shall be consistent with the selected architectural style and should be integrated into the design of the building.
- b. Column and railing designs and size should be consistent with the massing and detailing of the main building.
- c. Structural supports, such as columns, beams, purlins, brackets, rafter tails and trusses are encouraged to be expressed at roofs, decks, porches, balconies and building walls and used where they are needed to avoid the appearance of unsupported spans and cantilevers. Structural supports may be covered if appropriate to the architectural style of the building.
- d. For balconies, employ the following strategies:
  - i. To protect the privacy of adjacent neighbors, rear balconies facing existing units to the west shall be set back at least 35 feet from the property line.
  - ii. Minimum dimensions for balconies off living spaces, such as second story bonus rooms, lofts, or master bedrooms, should be five (5) feet. Balconies off secondary bedrooms should be a minimum of three (3) feet, with the exception of “Juliet” balconies, which may be a minimum of 12 to 18 inches.

- e. For porticos and porches, employ the following strategies:
  - i. To enhance curb appeal and foster a pedestrian-friendly street, porches should be used on primary facades.
  - ii. Portico or porch elements, such as columns, should not be disproportionate in scale, and should provide enough mass and scale to appear they are supporting roof elements of a porch. Columns that appear thin or weak, or conversely, too massive or heavy as it related to the roof element above, should be avoided.
  - iii. Minimum dimension for porches should be five (5) feet. Portico dimensions may vary depending on the selected architectural style.
  - iv. Porches should be architecturally integrated into the design of the structure.

### **5.5.10 Detached accessory structures and additions**

- a. Detached accessory structures (e.g., garages, carports, workshops, storage sheds, gazebos, accessory dwelling units, etc.) and additions should be consistent with the selected architectural style of the main building.
- b. Detached accessory structures and additions should be consistent with the applicable design standards and guidelines set forth in this chapter.
- c. Detached accessory structures should be subordinate in hierarchy to the main building and should be located to the rear of the lot.

- d. Additions should be set back from the main building façade.

## **5.6 Landscape Design**

### **5.6.1 Landscaping**

- a. Refer to **Chapter 3** for requirements on landscaping, fire hazard mitigation, and fuel modification, all of which affect the landscaping on site.
- b. Landscaping (e.g., trees, shrubs, flowers, hedges, groundcover, hardscape, etc.) should be designed with equal care and attention to detail as is the design of the building, and should be complimentary and consistent with the selected architectural style, whether installed by the developer, landscape maintenance district, or homeowner.
- c. Landscaping shall comply with the City Water Efficient Landscape Ordinance.
- d. Landscaping should be an integral component of the overall project design.
- e. Landscaping should provide for a balance and variety of plant selections, colors, sizes, shapes, textures, and arrangements.
- f. Landscaping should be used to:
  - i. Frame important viewsheds or elements of the building.
  - ii. Reduce the visual impact of the building to adjacent neighbors, public street views, and other downslope residences.
  - iii. Screen outdoor service areas.

## 5.6.2 Walls and Fences

- a. Wall and fence materials and elements should be consistent with the selected architectural style.
  - b. Refer to **Chapter 3** for requirements on walls and fences, including retaining walls, such as heights, placement, and materiality.
- b. Refer to CalGreen (the California Green Building Standards Code), as referred to and referenced in Chapter 15.30 – Green Building Standards Code, of the SMMC for requirements on using water- and energy-efficient materials, fixtures, and appliances; managing stormwater; recycling; and other sustainable practices.

## 5.6.3 Exterior lighting

- a. Exterior lighting materials and elements (structural support, such as posts, fixtures, etc.) should be consistent with the scale and design of the selected architectural style.
- b. The latest technical and operational energy conservation concepts in lighting designs should be considered.
- c. Exterior night lighting should be kept to a minimum as necessary for safety and address identification at entrances, driveways and buildings, and all light fixtures should be activated for short-term use only.
- d. Refer to **Chapter 3** for requirements on exterior lighting.

## 5.7 Sustainability

### 5.7.1 Water and energy conservation

- a. Refer to **Chapter 4** for requirements on grading, drainage, and water, and **Chapter 3** for requirements on landscaping, all of which affect water and energy conservation.



# 6 Implementation

## 6.1 Introduction

This chapter sets forth the implementation procedures for The Meadows at Bailey Canyon Specific Plan. The implementation procedures described below provide for the mechanisms for review and approval of development within the Meadows at Bailey Canyon Specific Plan area. This chapter also contains the mechanism for approving minor modifications and determining whether an amendment to the Specific Plan is required. Information regarding interpretation of the Specific Plan, appeals, project financing, phasing, and maintenance is also included in this chapter.

## 6.2 Implementation Procedures

The City of Sierra Madre (City) will adopt The Meadows at Bailey Canyon Specific Plan by ordinance. Following approval by the City, the Specific Plan will provide for the zoning for the Plan area. Development within the Plan area will be implemented through the subdivision mapping, design review, and permitting processes, as described below.

Before a permit of any type is granted, the developer shall demonstrate, to the reasonable satisfaction of the reviewing authority, that the proposed project is in substantial conformance with the Specific Plan and all applicable design standards. Where the Specific Plan development regulations and design guidelines are silent, the applicable development regulations and design guidelines contained within the Sierra

Madre Municipal Code (SMMC) shall apply. The design guidelines are intended to be flexible while establishing basic evaluation criteria for review by the City of developer projects during design review.

### 6.2.1 Tentative Tract Map

A Tentative Tract Map for the development of the Specific Plan shall be submitted, reviewed, and approved by the Planning Commission and City Council in accordance with Title 16, Subdivisions of the SMMC and consistent with the applicable provisions of the land use, mobility, pedestrian and paving, landscaping, tree and planting, open space, wall and fence, parks and recreation, infrastructure, development regulations, and design guidelines contained within this Specific Plan. As part of the Tentative Tract Map process, a new legal lot will be formed directly north of the Retreat Center (shown in orange on Figure 1-2). This lot will be one of three parcels to be conserved as open space and will be rezoned to the Open Space zone in the City's Zoning Code. The lot will be subject to a conservation easement prohibiting habitable structures from being constructed and will be for restricted use area.

### 6.2.2 Design Review

The proposed development of the Specific Plan shall be subject to the City's Design Review process and shall be processed concurrently with the project's Tentative Tract Map. The Planning Commission shall review the project in its entirety and make

a substantial conformance determination for the full set of architectural plans including the conceptual grading plan included in the Specific Plan (See **Figure 4-2**). The Design Review application shall include project elevations, floorplans, a color palette, materials boards, landscape plan, park plan, and 3-D computer renderings depicting the development from various vantage points within the project site, including views from the community park and street intersections. The Planning Commission shall review the application to ensure the proposed development is consistent with, and serves to implement, the goals, policies, standards, and design guidelines of the Specific Plan. No additional plans, materials, studies, environmental review, or technical analyses shall be required except as provided in **Chapters 3 and 4** of the Meadow Specific Plan or as otherwise required by law.

### **6.2.3 Final Engineering and Construction Documents**

Except for the Design Review process noted in **Section 6.2.2.**, the review and approval of all construction documents, final maps, CC&Rs, homeowners association and Community Facilities District, or other similar public maintenance district formation, grading plans, improvement plans, building permits, and associated technical reports shall be subject to the City's ministerial, administrative review process through the Director of Planning and Community Preservation and/or Director of Public Works, or his/her designee.

### **6.2.4 Final Public Park Design**

The review and approval of the final design of the public park shall be subject to a public design process subsequent to the

approval of the Specific Plan. As part of the public design process, the final public park design will be presented to the City's Community Services Commission for review after a public input process. The final park design shall be subject to a maximum of three public hearings.

### **6.2.4 Interpretation**

Unless otherwise provided, any ambiguity concerning the content or application of the Specific Plan shall be resolved by the Director of Planning and Community Preservation or his/her designee in a manner consistent with the vision, guiding principles, purpose, and intent established in this Specific Plan.

## **6.3 Relationship with the City's Municipal Code**

Although the Specific Plan includes a land use, mobility, pedestrian and paving, conceptual landscaping, tree and planting, open space, wall and fence, and conceptual parks and recreation plan, additional details regarding subsequent development will be required with subsequent application submittals. The Specific Plan includes development regulations and design guidelines but cannot foresee every potential condition requiring decisions within the Project Review Process. Any subsequent discretionary approval or amendment to the Specific Plan must be consistent with the General Plan. Future development applications will be processed that are in substantial conformance with the Specific Plan or that may require an amendment to the Specific Plan, as determined by the Director of Planning and Community Preservation or his/her designee.

## 6.4 Minor Modifications

The following minor modifications to the Specific Plan may be permitted by both the City Manager and Director of Planning and Community Preservation, subject to the granting of a minor conditional use permit or minor variance pursuant to Chapter 17.60 of the SMMC. The City Manager and Director of Planning and Community Preservation shall have the discretion to refer any such request for changes to the Planning Commission or the City Council. Notice of any request for a minor modification shall be provided to the Planning Commission and City Council.

- a. **Site Development Standards.** Minor changes to the site development standards set forth in the Specific Plan, including lot size and coverage, building height, setbacks, and unit mix requirements, that do not increase or decrease any one standard by more than 20%.
- b. **Design Guidelines.** Minor changes to the design guidelines, including changes in the exterior architectural styles, colors, or materials, so long as the changes are similar to and have the same general appearance comparable to or of a higher quality as the guidelines approved, and meet the intent of the design guidelines.
- c. **Mobility Plan.** Minor changes to the Mobility Plan, including modifications to the approved Pedestrian and Paving Plan, alignment, location and design of internal streets, and/or layout of the parking lot, provided that such adjustments do not change the requirement of providing adequate infrastructure and/or public facilities within the Plan area.
- d. **Park Plan.** Subsequent to the approval of the Conceptual Park Plan contained in this Specific plan, minor changes to the approved Park Plan, including modifications to the approved design and layout, park amenities, play equipment, and pedestrian paths, as long as the amount of open space provided and the number of recreational amenities remain consistent with the approved Park Plan.
- e. **Landscape Plan.** Minor changes to the Tree and Planting Plan, as well as landscape requirements set forth in **Chapter 3** and landscape design guidelines set forth in **Chapter 5** of this Specific Plan, as long as they do not exceed a 20% deviation from total tree and plant species and are compliant with the Los Angeles County Fire Department Fuel Modification Guidelines.
- f. **Wall and Fence Plan.** Changes to the Wall and Fence Plan, including modifications to the approved location and design of the walls and fences, provided that such adjustments are similar to and have the same intended function and/or general appearance comparable to or of a higher quality as the approved.
- g. **Stormwater Treatment Design.** Any changes to the stormwater treatment design, as long as the changes retain compliance with regional water quality standards regulations.



- h. **Other modifications** of a similar nature to those listed above that are deemed minor by the City Manager and Director of Planning and Community Preservation are in keeping with the purpose and intent of the approved Specific Plan and are in conformance with the General Plan.
- i. Increases to floor area, the location and number of one-story homes, or number of parking spaces within the public park's parking lot shall not be considered minor modifications.

## 6.5 Specific Plan Amendments

Amendments to the Specific Plan may be requested by the developer or by the City at any time pursuant to Section 65453(a) of the Government Code. Amendments shall be processed pursuant to the provisions of the Government Code for Specific Plan Amendments. If the proposed amendment requires supplemental environmental analysis pursuant to the California Environmental Quality Act (CEQA), the developer(s) are responsible for preparing the necessary CEQA documentation.

## 6.6 Appeals

Appeals from any determination of the City Manager or Director of Planning and Community Preservation shall be made to the Planning Commission. The developer(s), or any other entity, shall have the right to appeal the decision of the Planning Commission to the City Council any determination by filing an application on forms provided by the City within 10 days following the final date of action for which an appeal is made. Appeals shall be processed consistent with the provisions of Chapter 17.60.120, Appeal, of the SMMC.

## 6.7 Compliance with Mitigation Monitoring Plan

Certification of The Meadows at Bailey Canyon Specific Plan Environmental Impact Report (EIR) shall be required prior to approval of the Specific Plan. Development within the Plan area shall comply with all approved mitigation measures as described in the Mitigation Monitoring and Reporting Program included as part of the Specific Plan EIR.

## 6.8 Project Financing

Construction of the public utilities, improvements and facilities, and all public open space, including the public park, and payment of fees may be through public and/or private financing. Once construction of the public park is completed, the public park will be dedicated to the City and an assessment district (e.g., Landscape Maintenance District or similar public maintenance district) will be developed and administered by the City for the operation and maintenance of the public park and maintenance of open space, including the slopes between homes and open space lots, and the landscape buffer along the northern Plan area boundary, as shown in **Figure 3-8**. The grading and landscape buffer along the northern Plan area boundary will be maintained by the Mater Dolorosa Retreat Center. All other public improvements (e.g., streets, water, sewer and storm drains) will be maintained by the City. Final determination as to the facilities to be constructed and as to maintenance responsibilities, whether publicly or privately maintained, will be made prior to recordation of the final maps.

## 6.9 Project Phasing

Phasing of the Specific Plan shall meet the following objectives:

- Orderly build-out of the community based on market and economic conditions.
- Provision of adequate infrastructure and public facilities concurrent with development of the residential homes.
- Development of the park in accordance with conditions of approval.
- Protection of public health, safety, and welfare.

### 6.9.1 Residential Development and Public Park Phasing

Development of the single-family homes will be implemented through approval of tentative and final tract maps and development permits as described in Section 6.2 above. The timing of the park and open space amenities will be determined through the approval process and the conditions of approval. Appropriate levels of infrastructure and public facilities will be installed, and public services will be available to serve the residential development as it occurs.

### 6.9.2 Community Facilities and Services Phasing

Payment of impact fees for public improvements and services for the Specific Plan will be determined as part of the City's approval of tentative tract maps in accordance with any applicable development agreement associated with the project.

## 6.10 Maintenance

The public and private improvements constructed within the Plan area will be maintained through a combination of public and private entities, as described below:

- a. All streets within the Plan area, including the public parking lot, will be privately constructed and dedicated as public streets to the City, and will be maintained by the City.
- b. All on-site facilities, such as water, sewer, and storm drains, within street rights-of-way will be privately constructed and maintained by the City.
- c. As shown on **Figure 3-8, Open Space Plan**, common area landscaping, including landscaped parkways within the rights-of-way, the internal slopes fronting streets and slope areas in the rear of homes, open space lots, and the public park will be maintained by the City of Sierra Madre, Landscape Maintenance District or similar public Maintenance Assessment District. The grading and landscape buffer along the northern Plan area boundary will be maintained by the Mater Dolorosa Retreat Center.

# Appendix 1A

General Plan Consistency Analysis



Table 1. Consistency with City of Sierra Madre’s General Plan Goals and Policies

**Master Responses:**

**Response 1:** The Specific Plan includes development regulations and design guidelines and standards for the project site created to be compatible with the surrounding neighborhood. The development will be designed in a manner that is sensitive to viewpoints through building design, site layout and building heights. The design guidelines and standards in Chapter 5 promote the high-quality standards that the City and the community value. In addition, multiple measures are in place that will provide buffers, additional setbacks for lots west of North Sunnyside Avenue and landscaping, as well as a Grading and Landscape buffer along the northern boundary of the Plan area, to ensure compatibility with existing structures in the adjacent neighborhood and Retreat Center. See Section 3.8.5, Good Neighborhood Plan for additional details. See Section 3.8.5, Good Neighborhood Plan for additional compatibility details in regard to the site’s compatibility with surrounding uses.

**Response 2:** The development will have net-zero water usage for the first 50 years after construction (i.e. the expected life of the homes). This will be accomplished by pre-purchasing and obtaining water rights from San Gabriel Valley Municipal Water District on behalf of the City for the anticipated 50-year demand of the new homes, as described in Chapter 4. Additionally, the project would include the incorporation of green infrastructure into the design to promote water conservation through measures including on-site stormwater treatment per the MS4, the use of native/drought-resistant landscaping, and compliance with the City’s Water Efficiency Landscape Ordinance, as well as with the California Green Building Standards Code (CalGreen - Title 24), as referenced in Chapter 15.30 – Green Building Standards Code, of the SMMC, including requirements on installing water-conserving and energy-efficient fixtures and appliances, managing stormwater, recycling, building materials, and other sustainable practices.

**Response 3:** City’s Dark Sky Ordinance - The Specific Plan’s Developments Standards require that all lighting of the building, landscaping, parking area, or similar facilities shall be in compliance with the City’s “Dark Sky” Program. In addition, the Specific Plan’s Development Standards require that lighting shall be hooded and directed downward to reflect away from adjoining properties, that lighting shall be confined to the lot boundaries and not be oriented towards neighboring properties to protect privacy, and that pedestrian-scaled street lighting shall be provided within the proposed park areas pedestrian routes of travel to enable visibility and safety.

**Response 4:** California Green Building Standards Code (CalGreen - Title 24) - Development within the Plan area shall comply to the California Green Building Standards Code, as referenced in Chapter 15.30 – Green Building Standards Code, of the SMMC. CalGreen has a mandatory component for all new residential construction, including requirements on using water- and energy-efficient materials, fixtures, and appliances; managing stormwater; recycling; and other sustainable practices. The Specific Plan contains Design Guidelines and Standards including sustainable development attributes for water and energy conservation. As part of CalGreen, residential and nonresidential buildings within the Plan area shall comply with the state’s Building Energy Efficiency Standards.

**Response 5:** Fire Service: Sierra Madre Fire Department (SMFD) currently serves the Plan area and the surrounding area. SMFD is responsible for emergency medical calls, fire response, and inspection, and plan check services. The frequency of emergency response calls is expected to increase in the Plan area relative to existing conditions. However, due to the minor nature of the relatively low population growth expected from the development and because this growth falls well within the projected population growth for the City, the expected population growth is not considered substantial and has been accounted for in local and regional population projections. In addition, SMFD has reviewed the development and has determined that it would not have a significant effect on service demands.

**Response 6:** Fire Prevention and Landscaping: The Specific Plan’s Plant Palette was developed in consultation with the following documents: City’s Community Forest’s Management Plan; List of Recommended Trees Permissible in VHFHSZ Area; and LA County’s Fuel Modification Plant List. Vegetation management would occur as required by Fire Department regulations and applicable code requirements. The Specific Plan Development Standards include Fire Prevention and Landscaping Requirements, including fire protection criteria, and Fuel Modification. In addition, fuel modification guidelines are provided in Appendices 4a and 4b. Individual homeowners will be required to maintain horizontal space, adequately spaced and well-pruned vegetation, including trees, in order to eliminate ladder for fuels near structure and provide defensible space in accordance with the maintenance requirements in Chapter 8.36 of the SMMC, as mentioned in section 3.8.6 of the Specific Plan, and the guidelines as provided in the Specific Plan appendices. A Landscape Maintenance District will be developed and administered by the City for the maintenance of the public park and the HOA will maintain the open space, including landscaped parkways and slopes, and landscape buffer as shown on Figure 3-8, Open Space Plan in Chapter 3.

## The Meadows at Bailey Canyon General Plan Consistency

General Plan Goals and Policy	Consistency of Specific Plan
<b>Goal 2:</b> Preserve and enhance the diversity in the character of residential neighborhoods ensuring that new development is compatible in its design and scale with older established development in the surrounding neighborhood without attempting to replicate or mass produce a style of development.	<u>Consistent.</u> The Specific Plan would assist in the implementation of this Goal through the provision of development regulations and design guidelines and standards, which would be compatible with existing surrounding neighborhoods. SEE MASTER RESPONSE 1.
<b>Goal 3:</b> Ensure that development is done in harmony with its neighborhood, and preserves and protects privacy and mountain views of neighboring properties.	<u>Consistent.</u> The Specific Plan includes development regulations and design guidelines and standards for the project site created to be compatible with the surrounding neighborhood. The development will be designed in a manner that is sensitive to scenic viewpoints and/or viewsheds through building design, site layout and building heights. SEE MASTER RESPONSE 1.
<b>Goal 4:</b> Ensure that development is done to maximize water conservation practices to reduce and minimize the impact on the City's local water supply and the ability to serve its water customers.	<u>Consistent.</u> The development would comply with City requirements by having net zero water usage for the first 50 years after construction as described in Chapter 4. SEE MASTER RESPONSE 2.
<b>Goal 5:</b> Institute conservation measures so that the demand for water matches the City's local supply.	<u>Consistent.</u> This Policy is a responsibility of and directed to the City of Sierra Madre. However, the proposed project would incorporate water conservation strategies into the project design, including the use of native/drought-resistant landscaping.
<b>Goal 8:</b> Preserve existing and provide additional constructed and natural open space.	<u>Consistent.</u> The project would comply with the City's Goal of providing additional open space. The Specific Plan establishes open spaces zones on the project site, including the incorporation of a public park at the southern area of the Plan area, and includes the dedication to the City or other perpetual conservation of approximately 45 acres of open space hillside land. This ensures the perpetuity of the dedicated land as open space. Furthermore, the Landscape Maintenance District (LMD), which will be developed and administered by the City, and the Homeowners Association (HOA) will ensure the maintenance of the public park and open space within the Plan area, ensuring the maintenance and quality of the open space.
<b>Goal 9:</b> Preserve the hillside areas in order to protect the environment and mountain views, obtain a balance between developed areas and the hillside wilderness, and establish the role of the hillside as an entry point into wildland areas.	<u>Consistent.</u> The Specific Plan includes the dedication to the City or other perpetual conservation of approximately 45 acres of open space hillside land to the north of the Mater Dolorosa Retreat Center. Through this land dedication, open space at the foothills of the San Gabriel Mountains is preserved, which helps to ensure future development in that area will not obstruct Mountain views from Sierra Madre. SEE MASTER RESPONSE 1.
<b>Objective L1:</b> Continuing the existing pattern of residential housing development.	<u>Consistent.</u> The Specific Plan assists with the implementation of this Objective as it creates low-density residential and open space land uses that are similar to those surrounding the Plan area.
<b>Policy L1.6:</b> Require that new residential development, substantial remodeling and	<u>Consistent.</u> The Specific Plan incorporate water conservation strategies into the project design, including the use of



**The Meadows at Bailey Canyon General Plan Consistency**

additions comply with all adopted water conservation measures that reduce and minimize the impact on the City’s water supply and its ability to serve its water customers.	native/drought-resistant landscaping and net zero water usage for the first 50 years after construction. SEE MASTER RESPONSE 2.
<b>Objective L4:</b> Mitigating the impacts of new development on the City’s open space, trees, infrastructure, water, transit services, the character of existing development, and other public needs.	<u>Consistent:</u> The Specific Plan protects the City’s open space through the dedication to the City or other perpetual conservation of approximately 45 acres of open space hillside land, mitigates impacts to the City’s trees by adhering to the City’s Tree Preservation and Protection Ordinance, incorporates water conservation measures (see Master Response 2), provides a public park as a new public amenity, and provides a tree, infrastructure, and development plan consistent with the character of adjacent residential neighborhoods.
<b>Policy L4. 2:</b> Except for those single family residences that would not otherwise require a conditional use permit (CUP), development projects that cumulatively comprise over one acre of land on one or more parcels require a CUP unless a specific plan or master plan is approved for the proposed project.	<u>Consistent:</u> The Meadows is a development project that cumulatively comprises over one acre of land on one or more parcels, which requires a CUP, Specific Plan or Master Plan. As such, the Meadows Specific Plan will be approved for the proposed project and guide the development for the project area, which is consistent with the Policy.
<b>Policy L4. 3:</b> Ensure that new development and the expansion of existing uses incorporate water conservation measures that reduce and minimize the impact on the City’s water supply and its ability to serve its customers.	<u>Consistent:</u> The Specific Plan incorporates water conservation strategies into the development design. SEE MASTER RESPONSE 2.
<b>Objective L5:</b> Preserving the existing grid street pattern which promotes community life.	<u>Consistent:</u> The Specific Plan incorporates a Mobility Plan that is designed in a grid pattern typical of Sierra Madre’s existing grid street pattern. The Plan area will be connected to the existing street pattern through the extensions of North Sunnyside Avenue and Carter Avenue. North Sunnyside Avenue will provide access to the Plan area, the new public park, and thru access to the Retreat Center. Carter Avenue will provide a secondary access route to and from the Plan area to the existing Sierra Madre community.
<b>Policy L5. 1:</b> Prohibit the use of cul-de-sacs and require through streets in new subdivisions except when no other access is physically feasible due to property ownership, parcel location or other physical factors.	<u>Consistent:</u> The Specific Plan does not include plans for the use of cul-de-sacs. Streets A, B, and C are proposed as through streets, which connect to North Sunnyside Avenue and Carter Avenue.
<b>Objective L6:</b> Development that is done in harmony with its neighborhood and preserves and protects the privacy, mountain, and basin views of neighboring properties.	<u>Consistent:</u> The Specific Plan provides the framework for a development that is sensitive to scenic viewpoints and/or viewsheds through building design, site layout and building heights. SEE MASTER RESPONSE 1.
<b>Policy L6.2:</b> Ensure that any new or expanded structures in residential neighborhoods do not unreasonably obstruct significant mountain or basin views.	<u>Consistent:</u> The development is designed in a manner that is sensitive to scenic viewpoints and/or viewsheds through building design, site layout and building heights. SEE MASTER RESPONSE 1.
<b>Policy L6.3:</b> Ensure new and remodeled structures in residential neighborhoods to minimize placement of windows and decks with	<u>Consistent:</u> The development is designed to ensure new buildings would not include features within direct lines of sight inside neighboring homes and back yards. For example, the Specific Plan’s Design Guidelines and Standards cite “buildings

## The Meadows at Bailey Canyon General Plan Consistency

<p>direct lines of sight inside neighboring homes and back yards.</p>	<p>should be oriented to provide adequate light and air while protecting the privacy of adjacent neighbors.” In addition, multiple measures are in place that will provide buffers, additional setbacks for lots west of North Sunnyside Avenue and landscaping, which will provide privacy and ensure there is not a direct line of sight from the new homes in the Meadows Plan area into the homes of existing adjacent homes. See Section 3.8.5, Good Neighborhood Plan for additional details.</p>
<p><b>Objective L7:</b> Development that is compatible in its design and scale with the neighborhood.</p>	<p><u>Consistent.</u> The development would be compatible with existing surrounding neighborhoods by creating new low-density residential land uses, similar to the adjacent existing conditions. For example, the maximum height in the Specific Plan area is 25 feet, the same as the maximum height allowed in the adjacent neighborhoods zoned R-1. The minimum required lot area in the Specific Plan area is 7,800 square feet, similar to the minimum required lot area in the R-1 of 7,5000 square feet.</p>
<p><b>Policy L7. 1:</b> Maintain maximum lot coverage and floor area ratios which allow for adequate buffering from neighboring properties, usable private yard area, air circulation and light.</p>	<p><u>Consistent.</u> The Specific Plan includes development regulations, inclusive of maximum allowable floor area, building heights and setbacks, including additional rear yard setbacks for lots west of North Sunnyside Avenue to provide additional privacy to existing adjacent neighbors.</p>
<p><b>Policy L7.3:</b> Limit the height of new buildings to reflect the prevailing height patterns on the street and within the Sierra Madre community.</p>	<p><u>Consistent.</u> The Specific Plan includes development regulation, inclusive of a maximum building height reflecting the existing height patterns in the greater Sierra Madre community. The maximum height in the Specific Plan area is 25 feet, which is the same as the maximum height allowed in the adjacent neighborhoods zoned R-1 of 25 feet.</p>
<p><b>Policy L7.4:</b> Encourage new residential development to be compatible with and complement existing structures including the following:</p> <ol style="list-style-type: none"> <li>a. Maintenance of front, side, and rear yard setbacks.</li> <li>b. Use of landscaping to complement the design of the structure and reflect the Sierra Madre vegetation patterns, with an emphasis on sustainable, low-water use landscaping and use of permeable surfaces for hardscaping, and the use of irrigation equipment that automatically senses the need for water.</li> <li>c. Minimize paving in the front yard as necessary to accommodate driveways and pedestrian walkways.</li> <li>d. Require that covered parking be provided.</li> <li>e. Prohibit required parking from being located in the front yard setback except in the Residential Canyon Zone.</li> </ol>	<p><u>Consistent.</u> The Specific Plan includes development regulations and design guidelines and standards for the project site created to be compatible with the surrounding neighborhood. SEE MASTER RESPONES 1.</p>
<p><b>Policy L8.1:</b> Encourage the use of sustainable materials in the design and construction of structures and landscapes.</p>	<p><u>Consistent.</u> The Specific Plan incorporates sustainable design standards for structures and landscapes, such as low water use plants, and CalGreen requirements. SEE MASTER RESPONSE 2.</p>

**The Meadows at Bailey Canyon General Plan Consistency**

<p><b>Policy L8.2:</b> Incorporate water conservation measures in the zoning development standards for new construction and substantial remodeling or building expansion, including but not limited to green building construction, the percentage of permeable ground surfaces, building floor area limitations, lot coverage, landscaping and irrigation, greywater plumbing requirements, rainwater capture, and design review.</p>	<p><u>Consistent:</u> The Specific Plan serves as the zoning code for the Plan area. As such, the Specific Plan incorporates water conservation measures in the zoning development standards and complies with the California Green Building Standards Code. SEE MASTER REPONES 2.</p>
<p><b>Policy L8.3:</b> Consider a water impact fee to apply to new residential dwelling units and additions to existing development that increase water consumption, to fund water fixture retrofits of existing homes and other water conservation measures.</p>	<p><u>Consistent:</u> While the City is not imposing a water impact fee on the new residential dwelling units, water usage for the first 50 years after construction will be purchased on behalf of the City. SEE MASTER REPONES 2.</p>
<p><b>Objective L17:</b> Protecting views to and from hillside areas in order to maintain the image and identity of the City as a village of the foothills.</p>	<p><u>Consistent:</u> The development is designed in a manner that is sensitive to scenic viewpoints and/or viewsheds through building design, site layout and building heights. SEE MASTER REPONSE 1.</p>
<p><b>Policy L17.5:</b> Require that exterior lighting be directed away from adjacent properties and the night sky.</p>	<p><u>Consistent:</u> SEE MASTER RESPONSE 3.</p>
<p><b>Objective L44:</b> The preservation of natural open space areas as crucial to the distinctive character of Sierra Madre, and as a key feature of sustainability and public safety.</p>	<p><u>Consistent:</u> The Specific Plan includes the dedication to the City or other perpetual conservation of approximately 45 acres of open space hillside land to the north of the Mater Dolorosa Retreat Center.</p>
<p><b>Policy L44.1:</b> Support the purchase of hillside property by the Sierra Madre Mountains Conservancy and similar organizations.</p>	<p><u>Consistent:</u> While the Specific Plan does not specifically identify the Sierra Madre Mountain Conservancy as the recipient of the 45-acre open space north of the Mater Dolorosa Retreat Center, the proposed project, includes the dedication of the 45 acres to the City or other organization for perpetual conservation.</p>
<p><b>Objective 45:</b> Acquiring additional natural and constructed open space areas.</p>	<p><u>Consistent:</u> The Specific Plan includes the dedication to the City or other perpetual conservation of approximately 45 acres of open space hillside land to the north of the Mater Dolorosa Retreat Center, discussed in Chapter 1 of the Specific Plan, in accordance with the conditions outlined in the Memorandum of Understanding following adoption of the Specific Plan.</p>
<p><b>Housing</b></p>	
<p><b>Goal 1.0:</b> Maintain and enhance the quality of existing housing and ensure that new residential development is consistent with Sierra Madre’s small town character.</p>	<p><u>Consistent.</u> The Specific Plan includes development regulations (i.e. height and lot area requirements that are the same or comparable to adjacent R-1 development regulations) and design guidelines and standards for the project site created to be compatible with the surrounding neighborhood. SEE MASTER RESPONSE 1.</p>
<p><b>Policy 1.1:</b> Maintain sustainable neighborhoods with quality housing, infrastructure and open space that fosters neighborhood character and the health of residents.</p>	<p><u>Consistent:</u> The development would provide new, high-quality, low-density housing, infrastructure improvements, a public park, and open space. The public park and open space provides green space for residents to enjoy, promoting the health of residents.</p>



## The Meadows at Bailey Canyon General Plan Consistency

<p><b>Policy 2.1:</b> Encourage diversity in the type, size, price and tenure of residential development in Sierra Madre, while maintaining quality of life goals.</p>	<p><u>Consistent:</u> To ensure a harmonious integration and compatibility with the adjacent Sierra Madre community, while enabling a diversity of styles and eclecticism, the design of all buildings, inclusive of materials, elements, and details on a single lot shall be stylistically consistent with one of the four architectural styles included in the Specific Plan’s Appendix 5A, Architectural Styles Reference Guide.</p>
<p><b>Policy 2.2:</b> Provide adequate housing sites through appropriate zoning and land use designations, consistent with Sierra Madre’s regional housing growth needs.</p>	<p><u>Consistent:</u> The development would designate the site as Specific Plan (SP) and provide 42 new housing units to further the City’s regional housing growth needs.</p>
<p><b>Policy 2.5:</b> Encourage the construction of new, well designed second units in residential zones as a means of addressing a portion of Sierra Madre’s regional housing needs.</p>	<p><u>Consistent:</u> The Specific Plan includes secondary uses such as accessory dwelling units within the proposed RL land use zone of this Specific Plan, pursuant to the provisions in SMMC, Section 17.22, Second Units.</p>
<p><b>Goal 5.0:</b> Promote environmental sustainability through support of existing and new development which minimizes reliance on natural resources.</p>	<p><u>Consistent:</u> The Specific Plan contains Development Standards and Design Guidelines and Standards. SEE MASTER COMMENT 2.</p>
<p><b>Policy 5.2:</b> Promote the use of sustainable construction techniques and environmentally sensitive design for housing.</p>	<p><u>Consistent:</u> The Specific Plan contains Development Standards and Design Guidelines and Standards including sustainable development attributes for water and energy conservation. Additionally, development in the Specific Plan area will comply with CalGreen. SEE MASTER COMMENT 4.</p>
<p><b>Policy 5.3:</b> Promote the use of alternative energy sources such as solar energy, cogeneration, and non-fossil fuels.</p>	<p><u>Consistent:</u> The Specific Plan contains Design Guidelines and Standards for the use of solar panels on proposed structures and development standards referencing state’s Building Energy Efficiency Standards, which promote the use of alternative energy. SEE MASTER COMMENT 4. The California solar mandate requires new construction homes to have a solar photovoltaic (PV) system as an electricity source on all single-family residences and multi-family residences up to three stories high.</p>
<p><b>Policy 5.4:</b> Incorporate transit and other transportation alternatives such as walking and bicycling into the design of new development.</p>	<p><u>Consistent:</u> The Specific Plan includes a Mobility Plan, including a pedestrian plan, which incorporates pathways for walking into the design of the new development, including a pedestrian connection extending from Carter Avenue near the public park area to the Bailey Canyon Wilderness Park.</p>
<b><i>Economic Development</i></b>	
<p><b>Goal 3.</b> Sierra Madre as a destination point accenting the area’s natural beauty, artist community, and historic character.</p>	<p><u>Consistent:</u> The Specific Plan dedicates 45 acres of open space, in accordance with the conditions outlined in the Memorandum of Understanding following adoption of the Specific Plan, and provides access to the Mater Dolorosa Retreat Center and a pedestrian connection extending from Carter Avenue near the public park area to the Bailey Canyon Wilderness Park, which will help accent the area’s natural beauty and historic character.</p>
<p><b>PolicyL48.3:</b> Continue to allow home based businesses which do not negatively impact the residential neighborhoods in which they are located.</p>	<p><u>Consistent:</u> The Specific Plan allows Home Occupations as a secondary use in the RL zone, pursuant to the provisions in SMMC, Chapter 17.85, Home Occupations.</p>
<b><i>Circulation</i></b>	

## The Meadows at Bailey Canyon General Plan Consistency

<p><b>Goal 1.</b> A balanced transportation system which accommodates all modes of travel including automobiles, pedestrians, bicycles, and transit users.</p>	<p><u>Consistent:</u> The Specific Plan includes a Mobility Plan which provides for a circulation system utilizing private vehicular and non-vehicular modes of transportation in a system of public roadways and pedestrian pathways within the Plan area.</p>
<p><b>Goal 2.</b> Safe and well-maintained streets.</p>	<p><u>Consistent:</u> The Specific Plan includes a Mobility Plan which seeks to implement street sections that create a safe and pleasant small neighborhood environment through landscaped parkways, pedestrian pathways incorporated into portions of the Plan area as shown on the Specific Plan’s Paving and Pedestrian Plan. The LMD ensure the parkways and landscaping along the streets is well-maintained.</p>
<p><b>Goal 3.</b> Preservation of quiet neighborhoods with limited thru traffic.</p>	<p><u>Consistent:</u> The Specific Plan includes Guiding Principles such as “Provide safe and welcoming public access to the site from Sunnyside Avenue for motorists and pedestrians while minimizing traffic impacts to adjacent residential streets.” In addition, the only use that can be accessed thru the Plan area, is the gated Retreat Center north of the Plan area, which is expected to create a relatively low flow of thru traffic based on the Retreat Center’s usage.</p>
<p><b>Objective L51:</b> Developing a balanced and multi-modal transportation system to serve the needs of all roadway users, including motorists, public transit patrons, pedestrians, and cyclists.</p>	<p><u>Consistent:</u> The Specific Plan includes a Mobility Plan which provides for a circulation system utilizing private vehicular and non-vehicular modes of transportation in a system of public roadways and pedestrian pathways within the Plan area.</p>
<p><b>Policy L51.5:</b> Encourage and support the use of non-automotive travel throughout the City.</p>	<p><u>Consistent:</u> The Specific Plan includes a Mobility Plan, including a pedestrian plan, which incorporates pathways for walking into the design of the new development, including a pedestrian connection extending from Carter Avenue near the public park area to the Bailey Canyon Wilderness Park.</p>
<p><b>Policy L52.1:</b> Ensure that all pedestrians, particularly seniors and the disabled, are able to travel safely and easily throughout the City.</p>	<p><u>Consistent:</u> The Specific Plan’s Mobility Plan includes ADA accessible paths of travel and ADA ramp locations, and the parking lot for the public park includes an ADA-compliant parking space to ensure that all pedestrians, particularly seniors and the disabled, are able to travel safely and easily by using the ADA features.</p>
<p><b>Policy L52.9:</b> Explore the possibility of sidewalk continuity where feasible.</p>	<p><u>Consistent:</u> Within the Specific Plan’s Mobility Plan, sidewalks connect the community to the public park at the southern area of the Plan area. Although the project will not include off-site sidewalk improvements, a pedestrian connection extending from Carter Avenue near the public park will provide access to the Bailey Canyon Wilderness Park.</p>
<p><b>Objective L53:</b> Protecting residential neighborhoods from the intrusion of through traffic.</p>	<p><u>Consistent:</u> The Specific Plan’s Mobility Plan will develop new Streets A, B, and C and extend North Sunnyside Avenue and Carter Avenue to provide adequate circulation within the Plan area. However, while the extension of North Sunnyside Avenue will provide thru access to the Retreat Center, the flow of traffic is expected to be very low and thus not have a significant impact or cause an intrusion of through traffic. In addition, the public park will be located on the southern perimeter of the Plan area, minimizing traffic through the residential uses.</p>
<p><b>Objective L54:</b> Providing off-street parking requirements, on-street parking, and public</p>	<p><u>Consistent:</u> Residential parking within the Plan area will be provided within garages and on private driveways for single-</p>

## The Meadows at Bailey Canyon General Plan Consistency

parking facilities to maximize parking opportunities and address future parking needs.	family residential dwellings; public on-street parking occurs on both sides of North Sunnyside Avenue, on the west side of Carter Avenue and along the south side of Streets A, B, and C. In addition, off-street parking is provided in the park's public parking lot.
<b>Objective L56:</b> Maximizing accessibility for the disabled.	<u>Consistent:</u> The Specific Plan's Mobility Plan includes ADA accessible paths of travel and ADA ramp locations, and the parking lot for the public park includes an ADA-compliant parking space. See details on Figure 3-2, Specific Plan Mobility Plan in Chapter 3.
<b>Policy L56.1:</b> Make streets handicap-accessible with more ramps and curb cuts.	<u>Consistent:</u> The Specific Plan's Mobility Plan includes ADA accessible paths of travel and ADA ramp locations. See details on Figure 3-2, Specific Plan Mobility Plan in Chapter 3.
<b>Policy L56.2:</b> Identify locations for handicap parking stalls on the street, and also install and maintain those spaces.	<u>Consistent:</u> The public park's parking lot includes an ADA-compliant parking space.
<b>Chapter Two: Resource Management</b>	
<b>1. Hillside Preservation</b>	
<b>Goal 3.</b> Public access to the San Gabriel Mountains via parks, trails and roads	<u>Consistent:</u> The Specific Plan's Pedestrian Plan includes a pedestrian pathway connecting the east side of the Park area to Bailey Canyon Wilderness park.
<b>3. Dark Sky</b>	
<b>Goal 1.</b> Protection of the starlit sky to avoid deterioration of the viewing of dark sky as it is a valuable resource.	<u>Consistent:</u> SEE MASTER RESPONSE 3.
<b>Goal 3.</b> Consideration of neighboring properties and the community as a whole with regard to exterior lighting through the reduction of negative light impacts in the design of new exterior lighting schemes.	<u>Consistent:</u> SEE MASTER RESPONSE 3.
<b>Goal 4.</b> Energy conservation.	<u>Consistent:</u> SEE MASTER RESPONSE 4.
<b>Objective R1:</b> Protecting hillside areas to preserve their unique character.	<u>Consistent:</u> The Specific Plan includes the dedication to the City or other perpetual conservation of approximately 45 acres of open space hillside land to the north of the Mater Dolorosa Retreat Center.
<b>Objective R6:</b> Reducing light pollution, trespass, and unnecessary glare through the use of light shielding methods, and elimination of lighting that is misdirected, excessive, or unnecessary.	<u>Consistent:</u> SEE MASTER RESPONSE 3.
<b>Policy R6.1:</b> Require that all new development projects utilize light fixtures that shield the light source so that light is cast downward to avoid light spillage off site or upward into the sky.	<u>Consistent:</u> SEE MASTER RESPONSE 3.
<b>Policy R6.2:</b> Discourage continuous all-night exterior lighting and encourage motion sensor lighting.	<u>Consistent:</u> SEE MASTER RESPONSE 3.
<b>Policy R6.3:</b> Encourage the use of fixtures like the "shoe box" design that are capable of providing accurate light patterns, and can often be used for	<u>Consistent:</u> SEE MASTER RESPONSE 3.



The Meadows at Bailey Canyon General Plan Consistency

lighting without spilling onto the neighboring property and upward into the sky.	
<b>Objective R7:</b> Minimizing lighting use and intensity, utilizing the most efficient lighting technology.	<u>Consistent:</u> SEE MASTER RESPONSES 3 and 4.
<b>Objective R8:</b> The reasonable use of outdoor lighting for nighttime safety, utility, security, and enjoyment while preserving the ambiance of the night.	<u>Consistent:</u> SEE MASTER RESPONSE 3.
<b>Policy R8.1:</b> Encourage outdoor lighting to be designed and installed in a manner that confines the direct lighting rays to the property upon which the lighting is installed so as to protect adjacent and nearby residential districts and public rights-of-way, and reduce “skyglow.”	<u>Consistent:</u> SEE MASTER RESPONSE 3
<b>Policy R8.2:</b> Lighting in and near residential areas shall be minimal and shielded to prevent nuisance glare.	<u>Consistent:</u> SEE MASTER RESPONSE 3
<b>Policy R8.3:</b> Lighting attached to single-family home structures should not exceed the height of the eave, and residential lighting pole height restrictions can be considered to control light trespass on adjacent properties and upward into the sky.	<u>Consistent:</u> SEE MASTER RESPONSE 3
<b>Policy R8.4:</b> Provide adequate illumination of all streets, alleys, and public areas.	<u>Consistent:</u> SEE MASTER RESPONSE 3
<b>4. Tree Preservation</b>	
<b>Goal 1.</b> Continued preservation and protection of existing trees.	<u>Consistent:</u> The Specific Plan will adhere to the City’s Tree Preservation and Protection Ordinance (see chapter 12.20 of the SMMC) and includes a Tree and Planting Plan. SEE MASTER RESPONSE 6.
<b>Goal 2.</b> Increase of the City’s community forest.	<u>Consistent:</u> The Specific Plan includes a Tree and Planting Plan which includes the planting of new trees throughout the Plan Area. SEE MASTER RESPONSE 6.
<b>Objective R10:</b> Maintaining and enhancing the City’s significant tree resources.	<u>Consistent:</u> The Specific Plan includes a Tree and Planting Plan, which includes the planting of new trees throughout the Plan Area and will adhere to the City’s Tree Preservation and Protection Ordinance (see chapter 12.20 of the SMMC).
<b>Policy R10.2:</b> Continue to develop tree preservation and protection measures.	<u>Consistent:</u> The Specific Plan includes guidelines for tree maintenance, including in Appendix 4B, CalFire Defensible Space and Hardening (SEE MASTER RESPONSE 6), and will adhere to the City’s Tree Preservation and Protection Ordinance (see chapter 12.20 of the SMMC).
<b>Policy R10.8:</b> Continue to monitor construction projects with regard to grading and construction effects on trees, tree removal and replacement	<u>Consistent:</u> The Specific Plan includes a Tree and Planting Plan, which includes the planting of new trees throughout the Plan Area, and will adhere to the City’s Tree Preservation and Protection Ordinance, including the adequate replacement of protected trees if removed from the Plan area (see chapter 12.20 of the SMMC).

## The Meadows at Bailey Canyon General Plan Consistency

<b>5. Water Resources</b>	
<b>Goal 1:</b> Conservation of the City's water resources.	<u>Consistent:</u> The Specific Plan includes sustainable guidelines and strategies to conserve water resources and will have net zero water usage for the first 50 years after construction. SEE MASTER RESPONSE 2.
<b>Goal 3.</b> Growth that is linked to the availability of water.	<u>Consistent:</u> The development has secured water rights for the first 50 years after construction.
<b>Goal 5.</b> Meet or exceed water quality objectives.	<u>Consistent:</u> The Specific Plan will meet or exceed the water quality objectives listed in this consistency analysis. SEE MASTER RESPONSE 2.
<b>Objective R12:</b> Optimizing the use of water resources.	<u>Consistent:</u> The development will have net zero water usage. Supplemental water purchase will be based on the final design and associated usage calculations. SEE MASTER RESPONES 2.
<b>Policy R12.3:</b> Develop new ways to capture and percolate storm water.	<u>Consistent:</u> The Specific Plan has identified three drainage areas within the Plan area and proposed infrastructure improvements would include the installation of proposed storm drains and catch basins which would flow into a proposed underground retention storage gallery in the southern portion of the Plan area.
<b>Objective R14:</b> Ensuring adequate water availability for future growth in the City.	<u>Consistent:</u> The development will have net zero water usage. Supplemental water purchase will be based on the final design and associated usage calculations. The Sierra Madre Water Department would have sufficient available supply to meet the anticipated demand. SEE MASTER RESPONES 2.
<b>Objective R14.2:</b> Evaluate water availability in conjunction with public and private development projects.	<u>Consistent:</u> Water demand estimates were prepared as part of the Specific Plan. The Sierra Madre Water Department would have sufficient available supply to meet the anticipated demand. Supplemental water purchase will be based on the final design and associated usage calculations. See discussion provided in Chapter 4. SEE MASTER RESPONES 2.
<b>Objective R15:</b> Conserving water during times of drought.	<u>Consistent:</u> The Specific Plan would incorporate water conservation strategies into the project design. SEE MASTER RESPONSE 2.
<b>6. Waste Management/Recycling</b>	
<b>Objective R21:</b> Providing adequate waste disposal systems to meet the demands of existing and new development.	<u>Consistent:</u> Per the Meadows Environmental Impact Report, the Plan area's solid waste management services would be provided by Athens Services and the available capacity of the Scholl Canyon Landfill would be able to accommodate development allowed under the project.
<b>7. Air Quality</b>	
<b>Policy 22.2:</b> Prohibit the development of land uses and land use practices which would contribute significantly to poor air quality.	<u>Consistent</u> As evaluated by the Meadows Environmental Impact Report, the Specific Plan does will not include uses which would have significant impacts to poor air quality.
<b>Policy 22.3:</b> Establish controls and monitor uses in the City which contain operations or materials characterized by air pollutants which individually or cumulatively could significantly add to the air basin's degradation (e.g., furniture manufacturers using paints and finishes, automobile repair, printing, and reproduction, and dry cleaners).	<u>Consistent:</u> The Specific Plan proposes residential and recreation uses; both uses do not contribute significantly to the air basin's degradation.

## The Meadows at Bailey Canyon General Plan Consistency

<b>Policy 23.4:</b> Allow for local job opportunities including home-based businesses and telecommuting in Sierra Madre.	<u>Consistent:</u> The Specific Plan allows Home Occupations as a secondary use in the RL zone, pursuant to the provisions in SMMC, Chapter 17.85, Home Occupations.
<b>Chapter Three: Hazard Prevention</b>	
<b>1. Fire Safety</b>	
<b>Objective Hz1:</b> Providing adequate service levels of fire protection that meets the needs of Sierra Madre residents, businesses and visitors.	<u>Consistent:</u> SEE MASTER RESPONSE 5.
<b>Objective Hz2:</b> Providing adequate fire protection necessary for existing and future development.	<u>Consistent:</u> SEE MASTER RESPONSES 5 AND 6.
<b>Policy Hz2.1:</b> Continue to require all existing and new development to install and maintain adequate smoke detection systems.	<u>Consistent:</u> The development is located within a Very High Fire Hazard Severity Zone (VHFHSZ) and would meet all Fire Department regulations and applicable code requirements for building in these higher fire hazard areas, including as they pertain to smoke detection systems.
<b>Policy Hz2.2:</b> Continue to require all new development to install automatic fire sprinkler systems.	<u>Consistent:</u> The development is located within a Very High Fire Hazard Severity Zone (VHFHSZ) and would meet all Fire Department regulations and applicable code requirements for building in these higher fire hazard areas, including as they pertain to automatic fire sprinkler systems.
<b>Policy Hz2.3:</b> Continue to require review of building plans by a Fire Captain.	<u>Consistent:</u> The SMFD has reviewed the development and has determined that it would not have a significant effect on service demands. Building Plans will be submitted consistent with City requirements for any review required by the Fire Captain, therefore compliant with the policy's objective.
<b>Policy Hz2.4:</b> Consider water availability in terms of quantity and water pressure for safety purposes when considering the size and location of new residential construction.	<u>Consistent:</u> Water demand estimates were prepared as part of the Specific Plan as provided in Chapter 4. Water availability will be assured through the net-zero water impact. The Sierra Madre Water Department would have sufficient available supply to meet the anticipated demand. SEE MASTER REPOSNE 2. SEE MASTER REPSONE 5.
<b>Policy Hz2.5:</b> Assess the impacts of incremental increases in development density and related traffic congestion on fire hazards and emergency response time, and ensure through the development review process that new development will not result in a reduction of fire protection services below acceptable levels.	<u>Consistent:</u> The impacts were assessed as part of the Meadows Environmental Impact Report. Additionally, the SMFD has reviewed the development and has determined that it would not have a significant effect on service demands, see discussion in Chapter 4.
<b>Policy Hz2.6:</b> Continue to require that new development provides adequate hydrants and show sufficient evidence that there is adequate water supply/fire flow and that it is available to accommodate the fire protection needs of new construction.	<u>Consistent:</u> SEE MASTER RESPONSE 5. The development will meet all Fire Department regulations and applicable code requirements, including as they pertain to installation of fire hydrants.
<b>Policy Hz2.8:</b> Develop vegetation management plans that manage chemise and chaparral to ensure adequate firebreaks, to provide adequate access for fire protection water systems, and access for firefighting.	<u>Consistent:</u> SEE MASTER RESPONSE 6.



**The Meadows at Bailey Canyon General Plan Consistency**

<b>Objective Hz4:</b> Addressing emergency operations and disaster preparedness as a priority.	<u>Consistent:</u> The Specific Plan addresses public services in Chapter 4, Infrastructure and Public Services Plan.
<b>Objective Hz5:</b> Limiting fire hazard through brush and weed abatement.	<u>Consistent:</u> SEE MASTER RESPONSE 6.
<b>Policy Hz5.1:</b> Mandate annual brush removal from April to June.	<u>Consistent:</u> SEE MASTER RESPONSE 6.
<b>Policy Hz5. 3:</b> Promote voluntary efforts in tree trimming, and brush and weed abatement.	<u>Consistent:</u> SEE MASTER RESPONSE 6.
<b>2. Flood/Landslide</b>	
<b>Objective Hz6:</b> Addressing potential flooding and landslide hazards on public and private property.	<u>Consistent:</u> The Specific Plan's Infrastructure Plan includes stormwater conveyance as to not result in an increase of surface runoff that would result in flooding on or off site. The Specific Plan proposes the creation of two independent storm drain networks that convey site runoff to the MS4, shown on Figure 4-6, Proposed Drainage and described in detail in Chapter 4.
<b>Policy Hz6.1:</b> Require that all new development incorporates sufficient measures to mitigate flood hazards, including the design of containment systems to capture stormwater runoff on-site, and site grading that minimizes stormwater runoff from increased impervious surfaces, thereby addressing impacts to on-site structures and adjacent properties.	<u>Consistent:</u> The Specific Plan has identified three drainage areas within the Plan area and proposed infrastructure improvements would include the installation of proposed storm drains and catch basins which would flow into a proposed underground retention storage gallery in the southern portion of the Plan area.
<b>Policy Hz6.2:</b> Require that the landscape of open space areas provide the maximum permeable surface area to reduce site runoff, and prohibit the paving of a majority of these areas.	<u>Consistent:</u> The Specific Plan includes a Landscaping Plan and Tree and Planting Plan for open space and maintenance will be provided by the Landscape Maintenance District.
<b>Objective Hz8:</b> Maintaining adequate infrastructure to prevent flooding hazards.	<u>Consistent:</u> The Specific Plan's Infrastructure Plan includes stormwater conveyance as to not result in an increase of surface runoff that would result in flooding on or off site.
<b>Policy Hz8.1:</b> Require that residential tract developers be responsible for construction of drainage/storm drain systems improvements that are compatible with City and County systems within or adjacent to their project site.	<u>Consistent:</u> The Specific Plan's Infrastructure Plan addresses the Plan area's proposed drainage and water quality plan, water service, and wastewater service. As outlined in the memorandum of understanding, street improvements and undergrounding all utilities in consultation with the City will be required, including drainage/storm drain systems as included in Chapter 4.
<b>Policy Hz8.2:</b> Install required public storm drainage improvements.	<u>Consistent:</u> The Specific Plan's Infrastructure Plan addresses the Plan area's proposed drainage and water quality plan, water service, and wastewater service. As outlined in the memorandum of understanding, street improvements and undergrounding all utilities in consultation with the City will be required, including drainage improvements as included in Chapter 4.
<b>4. Noise</b>	
<b>Policy Hz14.1:</b> Formulate measures to mitigate noise impacts from mobile and stationary noise sources through compatible land use planning	<u>Consistent:</u> The Specific Plan's Open Space and Low Density Residential land uses are compatible with surrounding land uses.

**The Meadows at Bailey Canyon General Plan Consistency**

and the discretionary review of development projects.	
<b>Policy Hz14.5:</b> To the extent possible, protect schools, hospitals, libraries, churches, parks and recreational areas from excessive sound levels so as not to adversely affect their normal activities.	<u>Consistent:</u> The Specific Plan includes a grading and landscaping buffer along the northern Plan area boundary to provide a buffer between the Plan area and the Retreat Center. This area is envisioned to provide a visual landscape buffer and screening, as well as a wall for noise attenuation between the Retreat Center's existing amphitheater and lookout point and the proposed one- and two-story homes on the northern end of the Plan area.
<b>Chapter Four: Community Services</b>	
<b>1. Law Enforcement</b>	
<b>Policy C1.2:</b> Assess the impact of increases in population on response time, calls for service and traffic through the development review process so law enforcement assets will not be degraded.	<u>Consistent:</u> The Specific Plan would be served by the Sierra Madre Police Department (SMPD). Payment of development fees by the project applicant, as required by Chapter 15.52 of the Sierra Madre Municipal Code (SMMC), would be used to offset the costs of increased personnel or equipment that could be required in order to maintain acceptable service ratios, response times, and other performance objectives. Therefore, the SMPD would adequately serve the Plan area as assessed by the Meadows Environmental Impact Report.
<b>Policy C3.1:</b> Evaluate on a continual basis the delivery of police services to monitor their adequacy and responsiveness to community needs.	<u>Consistent:</u> The development fees required for this development, would help offset the costs of increased personnel or equipment that could be required in order to maintain acceptable service ratios, response times, and other performance objectives.
<b>Policy C4.3:</b> Maximize passive prevention measures for new and existing development through the development review process.	<u>Consistent:</u> The development fees required for this development, would help offset the costs of increased personnel or equipment that could be required in order to maintain acceptable service ratios, response times, and other performance objectives.
<b>2. Recreation Services</b>	
<b>Objective C6:</b> Providing quality recreation, leisure and social programs and facilities for the various segments of the Sierra Madre community	<u>Consistent:</u> The Specific Plan's Park Plan includes a publicly accessible neighborhood park.
<b>Policy C8.1:</b> Continue a park maintenance program to secure the existing nature and beauty of the City Parks and open space areas.	<u>Consistent:</u> The Specific Plan's Park Plan includes a publicly accessible neighborhood park, which would be maintained by the City of Sierra Madre, LMD, or similar public Maintenance Assessment District.
<b>Policy C8.4:</b> Identify each recreational site with its name and encompassing facilities with signage visible to the public	<u>Consistent:</u> Signage within the Plan area shall comply with the design requirements and procedures found within Chapter 17.72, Signs, of the SMMC. A Signage Plan is required to be reviewed and approved by the City of Sierra Madre Planning and Community Development Department. Signage plan shall include both temporary, construction, and permanent signage standards and guidelines.
<b>Objective C10:</b> Increasing parkland and recreational facilities in the City.	<u>Consistent:</u> The Specific Plan's Park Plan includes a publicly accessible neighborhood park.

## The Meadows at Bailey Canyon General Plan Consistency

<p><b>Policy C10.4:</b> Require that all new commercial and residential subdivision developments provide open space areas on-site for passive or active recreation or contribute fees for public development of such uses.</p>	<p><u>Consistent:</u> The Specific Plan's Park Plan includes a publicly accessible neighborhood park and the dedication of approximately 45 acres of open space hillside land.</p>
<p><b>Objective C11:</b> Coordinating the management of parks and recreation efforts throughout the City</p>	<p><u>Consistent:</u> The publicly accessible neighborhood park, will be operated and maintained by the City of Sierra Madre, LMD, or similar public Maintenance Assessment District.</p>
<p><b>Policy C11.2:</b> Maintain and update a maintenance and repair plan for existing and future City facilities.</p>	<p><u>Consistent:</u> The publicly accessible neighborhood park, will be operated and maintained by the City of Sierra Madre, LMD, or similar public Maintenance Assessment District.</p>
<p><b>5. Transit Services</b></p>	
<p><b>Objective C30:</b> Improving traffic safety.</p>	<p><u>Consistent:</u> The Specific Plan includes a Mobility Plan which provides for a circulation system utilizing private vehicular and non-vehicular modes of transportation in a system of public roadways and pedestrian pathways, which seeks to implement street sections that create a safe and pleasant small neighborhood environment through landscaped parkways, and pedestrian pathways incorporated into the Plan area as shown on the Specific Plan's Paving and Pedestrian Plan.</p>
<p><b>Policy C30.3:</b> Maintain safety and efficient circulation without impacting the village atmosphere.</p>	<p><u>Consistent:</u> The Specific Plan includes a Mobility Plan which seeks to implement street sections that create a safe and pleasant small neighborhood environment through landscaped parkways, and pedestrian pathways incorporated into portions of the Plan area as shown on the Specific Plan's Paving and Pedestrian Plan.</p>
<p><b>6. Public Services</b></p>	
<p><b>Objective C31:</b> Providing adequate water, wastewater/sewer, storm drainage, electrical, and telecommunications systems to meet the demands of new and existing development.</p>	<p><u>Consistent:</u> The Specific Plan's Infrastructure Plan addresses the Plan area's proposed drainage and water quality plan, wastewater service and dry utilities to meet the demand of the new development in the Plan area. The net-zero water usage helps ensure water demand is met for the new development. SEE MASTER RESPONSE 2.</p>
<p><b>Policy C31.3:</b> Require that new development be contingent upon the ability to be served by adequate sanitation collection and treatment, water, electrical and natural gas energy, telecommunication, storm drainage, and other supporting infrastructure.</p>	<p><u>Consistent:</u> Chapter 4 of the Specific Plan addresses Public Services and the Specific Plan's Infrastructure Plan addresses the Plan area's proposed drainage and water quality plan, water service, wastewater service and dry utilities to meet the demand of the new development in the Plan area.</p>
<p><b>Policy C31.5:</b> Require that new development capture for percolation on site the maximum practical amount of storm water.</p>	<p><u>Consistent:</u> The Specific Plan has identified three drainage areas within the Plan area and proposed infrastructure improvements would include the installation of proposed storm drains and catch basins which would flow into a proposed underground retention storage gallery in the southern portion of the Plan area.</p>



INTENTIONALLY LEFT BLANK

INTENTIONALLY LEFT BLANK

# Appendix 1B

## Workshop #1 Summary





## Retreat Center Project Workshop #1 Summary Conducted August 4, 2020

On August 4, 2020, the City of Sierra Madre, with the assistance of MIG, Inc. (urban planning and design consultants), conducted a community workshop to introduce a concept development plan on a portion of the Mater Dolorosa Retreat Center property. Three two-hour workshop sessions were conducted to ensure the number of participants complied with COVID-19 public gatherings’ restrictions. Each workshop was structured with two parts: 1) as an open house during the first 30 minutes to allow attendees to review presentation boards of the proposed subdivision and park and 2) as a presentation with a question and answer session during the following 90 minutes. During the question and answer session, MIG staff graphically recorded the questions and comments from attendees, as well as responses from City staff and applicant team representatives. Those interchanges are presented below from each of the three sessions. Also, attendees had the opportunity to record comments and ideas on a card. Card responses are presented following the graphic recording summary.

Workshop presenters included:

### City Staff

- Gabe Engeland – City Manager
- Vincent Gonzalez – Director of Planning and Community Preservation

### Applicant Team

- Jonathan Frankel – New Urban West
- Cameron Thornton – Mater Dolorosa Development Task Force

In addition to the in-person workshop, the City conducted a similar workshop via Zoom the evening of August 5, 2020. A video recording of that meeting is available on the City’s website.

### Session #1 Questions and Comments

Comment/Question	Response
Net zero project components are?	- 20-year contribution to water fund - Water/Resource Programs; low-flush toilets
Water capture opportunities	- LID water detention - Channel - Pervious surfaces - Dry creek as buffer and water capture
Hillside parcel protection?	No development – potential trail opportunity
Development – gated?	No
Public access to Retreat Center?	Will reopen post Covid-19
Access to Bailey Canyon?	This will be a secondary access road
Lot width and depth?	Yet to be determined

Will roads be widened, including Bailey Canyon access?	<i>To be determined</i>
Plan to widen Sunnyside?	<i>No</i>
Who pays for infrastructure?	<i>Developer</i>
Lighting?	<i>Will respond to night sky ordinance</i>
• Link trail to existing system, including landscape	<i>Yes - Respond to tree ordinance</i>
How large will park be?	<i>3 acres</i>

## Session #2 Questions and Comments

Comment/Question	Response
Consider broader housing needs	- <i>Housing advocates</i> - <i>Higher density</i>
How large will the homes be?	<i>2,600 to 3, 800 square feet</i>
Parking at park?	<i>Yes</i>
Mitigate the size of new homes	
Any modifications to retreat parcels?	<i>None planned at this time</i>
Park uses should potentially be placed below	<i>Setting like Sierra Vista</i>
What will happen in the 45 acres of hillside?	<i>Trails or preservation</i>
Need active recreation space, like ball fields	
Construction schedule?	<i>From complete entitlement: 2-3-year construction period</i>
Sunnyside circulation will suffer	<i>Widened access via Carter is possible</i>
Consider limiting construction on traffic to Michillinda	
Outreach during COVID-19: bad timing	
Preserve open space for wildlife	<i>This is private property but the city is engaged.</i>
Impacts from added traffic are of concern	
Sunnyside has limits to widening	<i>Carter will be an access.</i>
3-acre park remaining for development?	<i>No</i>
Two-story or one-story homes?	<i>Not determined</i>
Fire risk mitigation?	- <i>Fire separation regulations</i> - <i>Sprinklers</i> - <i>Section 7A noncombustible</i> - <i>Vegetation regulations</i>
What is the lot size for 2,600-square-foot home?	- <i>8,600 square feet</i> - <i>Specific Plan could require alternative</i> - <i>Could reduce park size</i>
Smaller homes and lots = larger park	
Infrastructure maintenance responsibility: City vs. developer?	<i>Developer</i>
Any reduction in Bailey Canyon Park?	<i>Unknown</i>
Bailey Canyon - keep nature feel	<i>Improvement - ADA</i>

Comment/Question	Response
Will new homes include pools?	<i>Not determined</i>
Loss of privacy for Sunnyside homes	
Residential use not compatible with Retreat	

### Session #3 Questions and Comments

Comment/Question	Response
Are buildings larger than needed?	<i>Concepts only shown at this time</i>
Impacts to adjacent neighbors: - Traffic speeds and volumes - Views/privacy - Decline in home values - Proximity to new development – neighbors - Must consider density/buffers: 20 ft buffer inadequate	
How will impacts on water resources be addressed?	<i>Supply is adequate for additional development Net-zero water use committed</i>
Fire risk	<i>Built to new state regulations</i>
Westside home impacts	
Impacts- light pollution Consider solar power motion-sense light	<i>Shield toward ground</i>
Use pervious pavement	<i>LID water capture will be included</i>
Will Bailey Park improvements be done?	<i>Possibly parking improvements</i>
Construction impacts: noise/dust	<i>To be studied in EIR</i>
Easement? Buffers removed?	<i>Backyards will provide buffers</i>
Recent weed abatement has destroyed vegetation	
Will earthquake faults cancel the project if they exist?	<i>Unknown</i>
Fire insurance will be hard to acquire	
Will park include parking?	<i>Yes</i>
Gated vs open?	<i>Open</i>
Why is lighting provided?	<i>Safety</i>
Use of natural area (above Retreat) will be?	- <i>Open space</i> - <i>Walking</i>
Consider no park	
Could bring visitors from other areas	



## Comment Cards

Twelve comment cards were received from the three sessions. Comments are transcribed here, edited for punctuation and clarity.

### #1

Thank you for your thoroughness of information. It is my hope that no plan uses only Sunnyside. Might it be possible to develop both Carter side and Sunnyside for in/out because Sunnyside will be overloaded by the increased traffic if the only way in or out, regardless of whatever project happens. And will the gates be removed? I live 4 houses down Sunnyside currently. Will I be able to walk to park at an hour of my choosing? (even if eaten by bear). Thank you again for all the information and openness!!! Keep park open 24/7!!!!

### #2

- I am totally opposed to this project. I have lived on the westside of the Monastery.
- I am concerned about the effect of the development with health concerns.
- I have lived here for 45 years and never have seen the meadow in the current condition.
- I have also contacted Retreat Center regarding any spraying on their property and was told that they no longer did any spraying.
- If the Monastery needs money, why they cannot think of something else, how about a cemetery?
- Also, the Monastery was always concerned at having anyone on their property and fenced their property. How will they prevent all the new development from going onto their property?

### #3

I love the idea for the hillside parcel left alone

### #4

Gabe- Good job! It will be developed. So, your approach is approved for the city.

### #5

- Still worried about water use, as most if not all residents have already retrofitted their property for low water use, including low-flow fixtures.
- Also, re: street access. Ingress needs to be considered in getting out in case of fire. Traffic patterns considerate to impact all streets, not just Sunnyside and Carter.
- Differentiate house design, placement, setbacks, color, layout, roof design.

### #6

Crowding another lot of homes in that space creates a hazard. Are rent and insurance premiums going up? Some homes are not insurable any longer. All these homes with views are going to lose \$100,00 to \$200,000 value in home prices. Plus, all the noise, traffic, and dust for the next two years. There will be no longer any peace and quiet. That little piece of nature will be lost forever. Very sad!! Leave the natural landscape alone. Also, there is no water pressure at this time.

## #7

I did appreciate the invitation to listen and participate in this community workshop. I cannot deny my frustration and disappointment that this property development is happening and to the scale as proposed. I wish the interest to monetize would envision more passive use. My dream has been they consider a Hospice Center as a quiet and spirited location for individuals and their people to face dying peacefully and with integrity. Developing huge, unnecessarily large homes simply perpetuates the wasteful ugly side of our consumer-focused society. I will make an effort to attend as many other workshops or meetings that follow.

## #8

1. Medical Issues – asthma, allergies, pulmonary
2. Soil testing results mailed to the residents. The field was sprayed with chemicals and it's shown no progress. How was it done? Powder, spray? I questioned it; no call back.
3. Where is the water coming from?
4. Fire hazard
5. Pollution
6. Stop the development. There are too many problems.
7. Property values
8. Enjoyment of life

## #9

1. Too close on the westside to the westside neighbors
2. Need to know if 1-story is maximum height
3. Net zero water use idea will hurt us in another drought
4. Traffic and congestion in town
5. Displacement of wildlife
6. Traffic on Sunnyside and Carter
7. What about views, privacy, and loss of land value for immediate neighbors?
8. Why moving forward during a pandemic?

## #10

Why are the houses being built in front of the monastery? Would be so nice if this land were saved and a beautiful park built on all the property.

## #11



I think the low-density housing project is an optimal project for this site. I would just like to make sure the park is complementary to Bailey Park. Bailey Park could use newer picnic and BBQ facilities, an outdoor amphitheater or meeting space would be great too. I would love to see public art element incorporated as well. But overall...thumbs up!

**#12**

I do not support this project whatsoever. It is unacceptable that the city is ever considering this huge project. The city should have a moratorium in place until the pandemic is over. It is not the same as a property request for residents. I guess it's easier to get something like this through during a global pandemic. I'm disappointed with the monastery; they are supposed to propagate faith and instead are more concerned with monetary. I'm concerned Sierra Madre will be changed in a bad way irreparably with this project.

**Park Amenities**

The comment cards asked participants to weigh in on conceptual park amenities.

Public Park Amenities			
Picnic Area	4	4	3
Community Garden	4	1	6
Fitness Station	3	0	7
Playground	4	4	2
Open Field	6	3	1
Children's Garden	5	1	4
Nature Trail	5	5	1

**Any other Ideas for park amenities?**

Native Garden to support – Bees, Birds – Butterflies.

Little League, Tee Ball, Softball field and soccer field.

Leave natural land as is – No homes, no traffic, no noise, and less crime.

What is the distance of the proposed trail? Will it be walking/running only? Will bikes and skateboards/hover craft be permitted?

More open space and trees than amenities.

Have Bailey Canyon next door – resident – are tied in with Bailey Canyon – or better develop use access – with parks, etc. – be a coherent pair.



# Appendix 3A

## Figure Enlargements

# Paving and Circulation Plan Enlargements

- Standard Site Pedestrian Pavement  
Potential Materials:
  - Natural gray paving with etched or broom finish
  - Decomposed granite
  - Integral color concrete with etched finish
  - Precast concrete pavers
- Specialized Resilient Surfacing
- Enhanced Vehicular Pavement at Project Entry  
Potential Materials:
  - Integral color concrete with decorative scoring
  - Precast concrete pavers

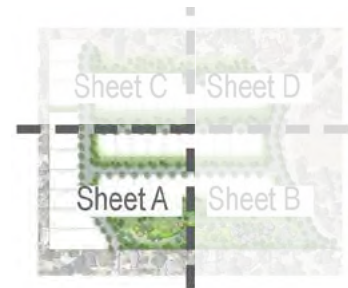
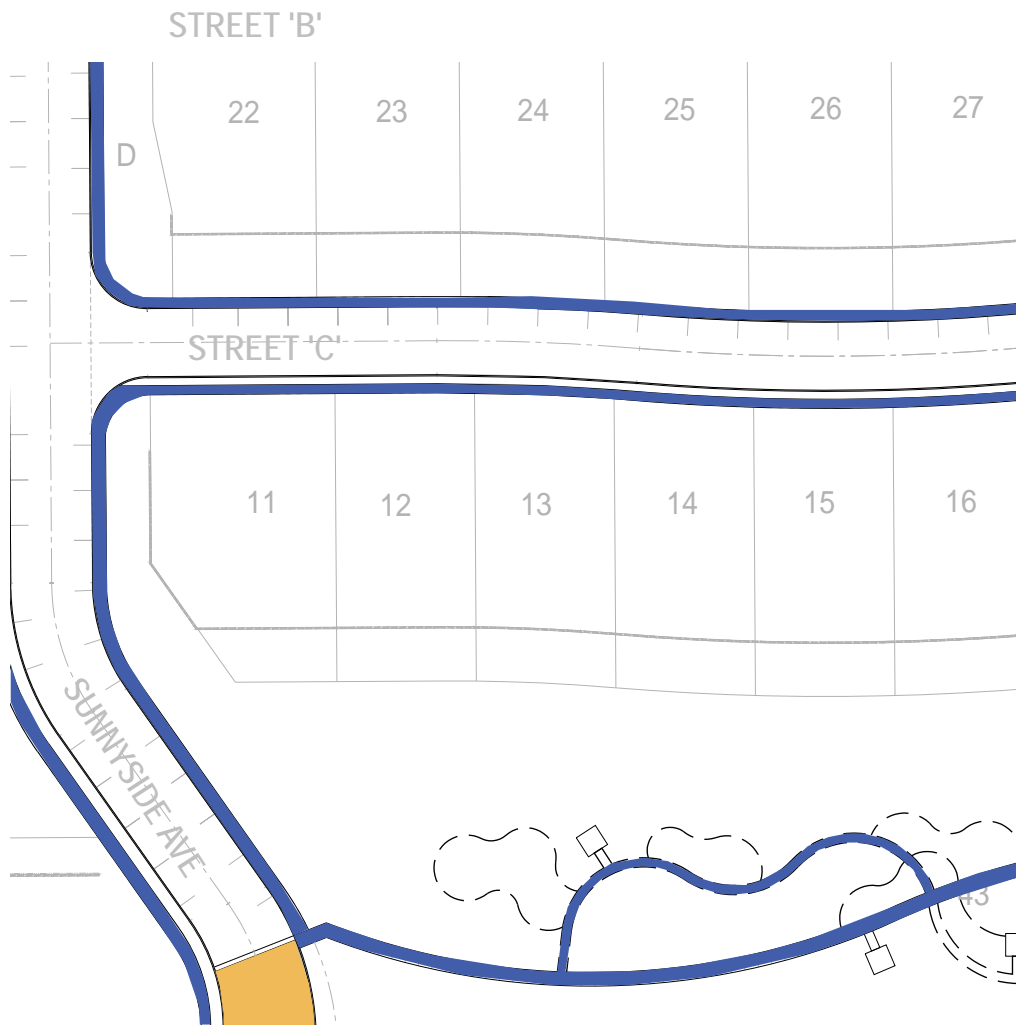

# Paving and Circulation Plan Enlargements

- Standard Site Pedestrian Pavement  
Potential Materials:
  - Natural gray paving with etched or broom finish
  - Decomposed granite
  - Integral color concrete with etched finish
  - Precast concrete pavers
- Specialized Resilient Surfacing
- Enhanced Vehicular Pavement at Project Entry  
Potential Materials:
  - Integral color concrete with decorative scoring
  - Precast concrete pavers





# Paving and Circulation Plan Enlargements

- Standard Site Pedestrian Pavement  
Potential Materials:
  - Natural gray paving with etched or broom finish
  - Decomposed granite
  - Integral color concrete with etched finish
  - Precast concrete pavers
- Specialized Resilient Surfacing
- Enhanced Vehicular Pavement at Project Entry  
Potential Materials:
  - Integral color concrete with decorative scoring
  - Precast concrete pavers

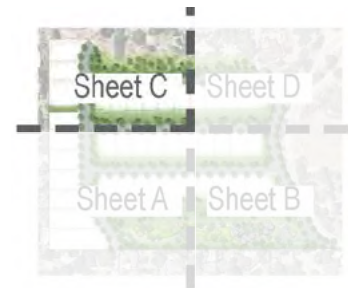
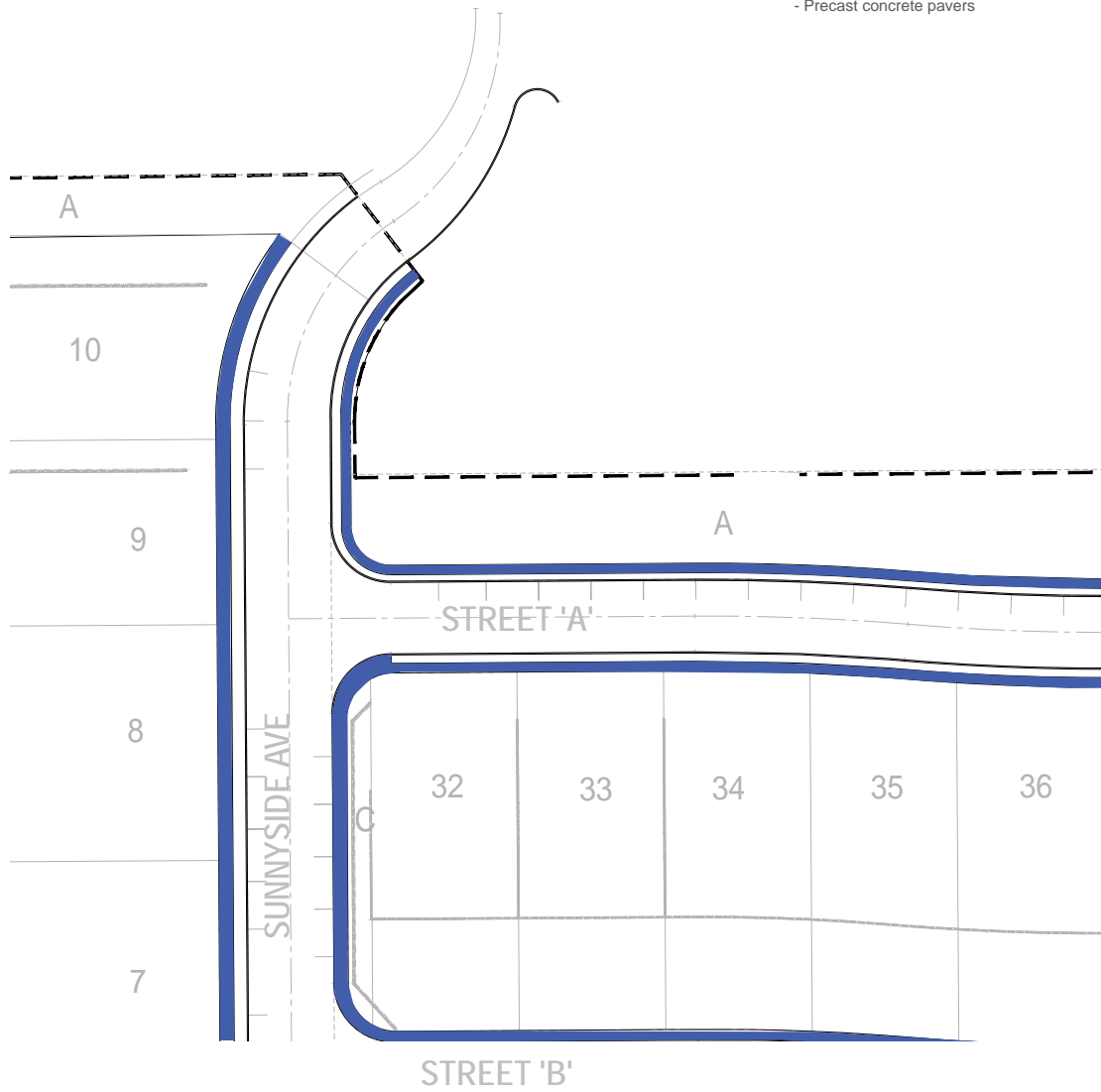



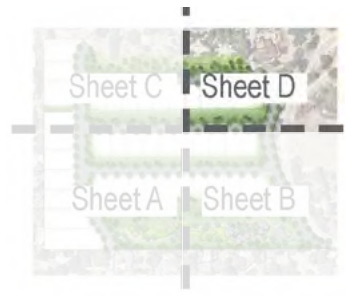
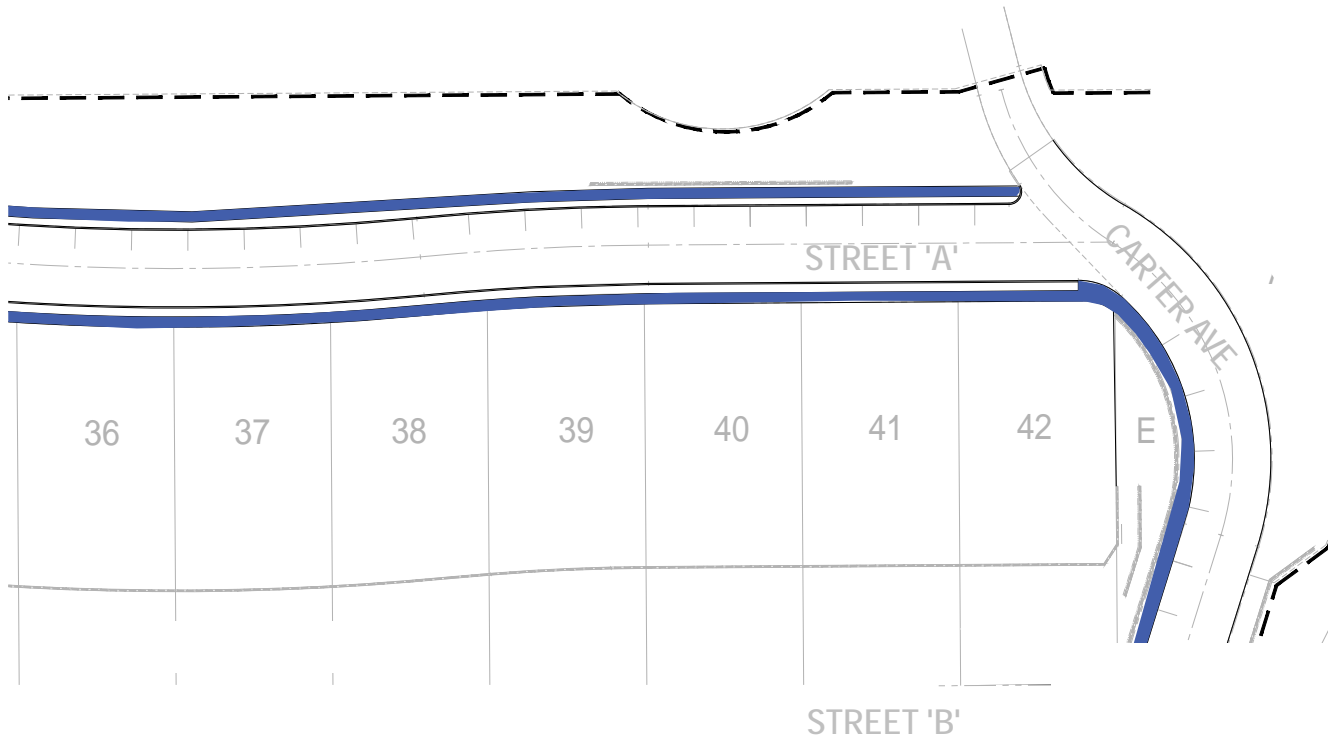

# Paving and Circulation Plan Enlargements

- Standard Site Pedestrian Pavement  
Potential Materials:
  - Natural gray paving with etched or broom finish
  - Decomposed granite
  - Integral color concrete with etched finish
  - Precast concrete pavers
- Specialized Resilient Surfacing
- Enhanced Vehicular Pavement at Project Entry  
Potential Materials:
  - Integral color concrete with decorative scoring
  - Precast concrete pavers



# Tree & Planting Plan Enlargements

- 
**Street Trees**  
 Arbutus "Marina" - STD - Marina Strawberry Tree  
 Lagerstroemia SPP. - STD. - Crape Myrtle  
 Koelreuteria Paniculata - STD. - Golden Rain Tree
- 
**Slope Trees**  
 Arbutus Unedo - Multi - Strawberry Tree  
 Cercis Occidentalis - Multi - Western Redbud  
 Lophostemon Confertus - Brisbane Box
- 
**Park Trees**  
 Platanus Racemosa - Western Sycamore  
 Olea Fruitless - Fruitless Olive  
 Quercus Agrifolia - Coast Live Oak  
 Quercus Virginiana - Southern Live Oak
- 
**General Planting Areas (Shrubs, Groundcover, and Vines)**
- 
**Turf (Species TBD)**

Vines shall be planted on walls facing park and public open spaces to minimize potential for graffiti.

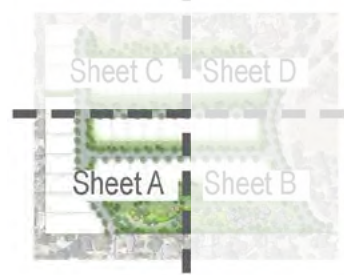



# Tree & Planting Plan Enlargements

**Street Trees**  
 Arbutus "Marina" - STD - Marina Strawberry Tree  
 Lagerstroemia SPP. - STD. - Crape Myrtle  
 Koelreuteria Paniculata - STD. - Golden Rain Tree

**Slope Trees**  
 Arbutus Unedo - Multi - Strawberry Tree  
 Cercis Occidentalis - Multi - Western Redbud  
 Lophostemon Confertus - Brisbane Box

**Park Trees**  
 Platanus Racemosa - Western Sycamore  
 Olea Fruitless - Fruitless Olive  
 Quercus Agrifolia - Coast Live Oak  
 Quercus Virginiana - Southern Live Oak



**General Planting Areas (Shrubs, Groundcover, and Vines)**

**Turf (Species TBD)**

Vines shall be planted on walls facing park and public open spaces to minimize potential for graffiti.

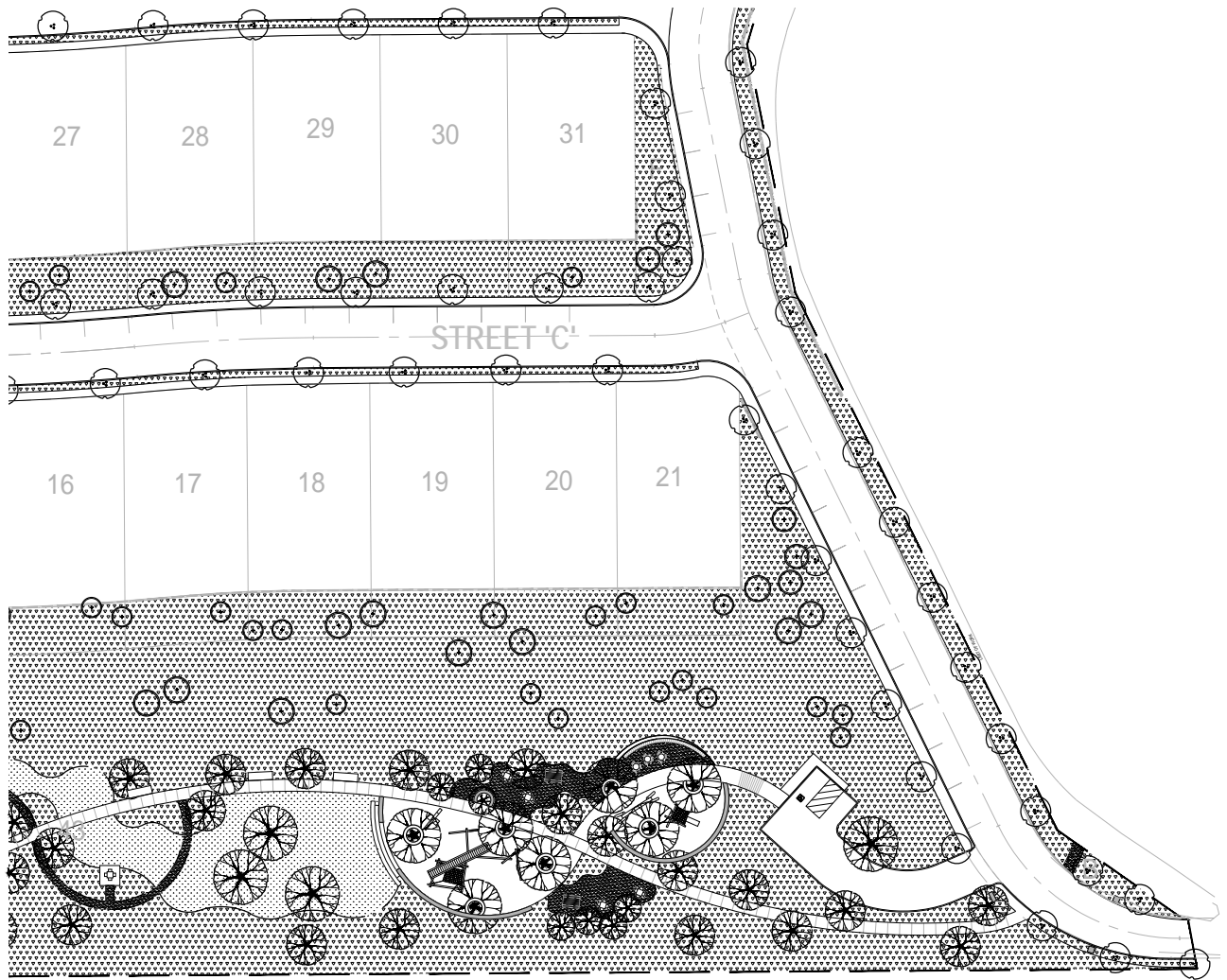



# Tree & Planting Plan Enlargements

-  **Street Trees**  
 Arbutus "Marina" - STD - Marina Strawberry Tree  
 Lagerstroemia SPP. - STD. - Crape Myrtle  
 Koelreuteria Paniculata - STD. - Golden Rain Tree

-  **Slope Trees**  
 Arbutus Unedo - Multi - Strawberry Tree  
 Cercis Occidentalis - Multi - Western Redbud  
 Lophostemon Confertus - Brisbane Box





-  **Park Trees**  
 Platanus Racemosa - Western Sycamore  
 Olea Fruitless - Fruitless Olive  
 Quercus Agrifolia - Coast Live Oak  
 Quercus Virginiana - Southern Live Oak

-  **General Planting Areas (Shrubs, Groundcover, and Vines)**
-  **Turf (Species TBD)**

Vines shall be planted on walls facing park and public open spaces to minimize potential for graffiti.



# Tree & Planting Plan Enlargements

- 
**Street Trees**  
 Arbutus "Marina" - STD - Marina Strawberry Tree  
 Lagerstroemia SPP. - STD. - Crape Myrtle  
 Koelreuteria Paniculata - STD. - Golden Rain Tree
- 
**Slope Trees**  
 Arbutus Unedo - Multi - Strawberry Tree  
 Cercis Occidentalis - Multi - Western Redbud  
 Lophostemon Confertus - Brisbane Box
- 
**Park Trees**  
 Platanus Racemosa - Western Sycamore  
 Olea Fruitless - Fruitless Olive  
 Quercus Agrifolia - Coast Live Oak  
 Quercus Virginiana - Southern Live Oak
- 
**General Planting Areas (Shrubs, Groundcover, and Vines)**
- 
**Turf (Species TBD)**

Vines shall be planted on walls facing park and public open spaces to minimize potential for graffiti.





# Wall & Fence Plan Enlargements

- Slump Block
- Slump Block with Sac Finish
- Top of Slope View Fence
- Retaining Wall (Height Varies)
- Slump Block Pilaster with Sac Finish
- Thematic Community Pilaster /Monument

\*Vines shall be planted on walls facing park and public open spaces to minimize potential for graffiti.  
 \*\* Wall locations subject to change provided they meet height guidelines within the specific plan.  
 \*\*\* Top of wall footings shall be at least 18" below grade to allow for vine planting immediately in front of wall face.



# Wall & Fence Plan Enlargements

- - - - - Slump Block
- — — — — Slump Block with Sac Finish
- - - - - Top of Slope View Fence
- — — — — Retaining Wall (Height Varies)
- Slump Block Pilaser with Sac Finish
- Thematic Community Pilaster /Monument

\*Vines shall be planted on walls facing park and public open spaces to minimize potential for graffiti.  
 \*\* Wall locations subject to change provided they meet height guidelines within the specific plan.  
 \*\*\* Top of wall footings shall be at least 18" below grade to allow for vine planting immediately in front of wall face.

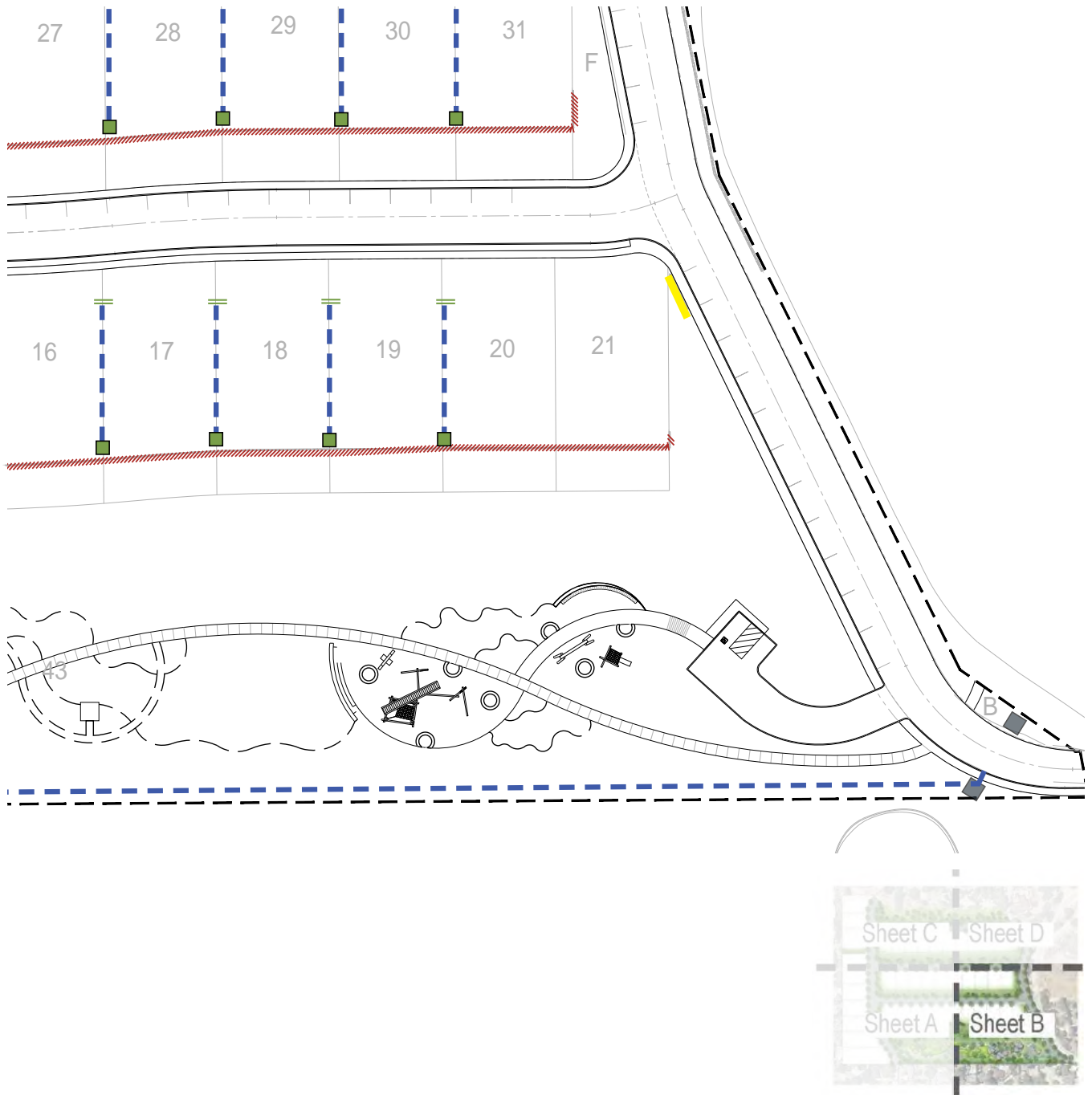

# Wall & Fence Plan Enlargements

- Slump Block
- Slump Block with Sac Finish
- Top of Slope View Fence
- Retaining Wall (Height Varies)
- Slump Block Pilaster with Sac Finish
- Thematic Community Pilaster /Monument

\*Vines shall be planted on walls facing park and public open spaces to minimize potential for graffiti.  
 \*\* Wall locations subject to change provided they meet height guidelines within the specific plan.  
 \*\*\* Top of wall footings shall be at least 18" below grade to allow for vine planting immediately in front of wall face.

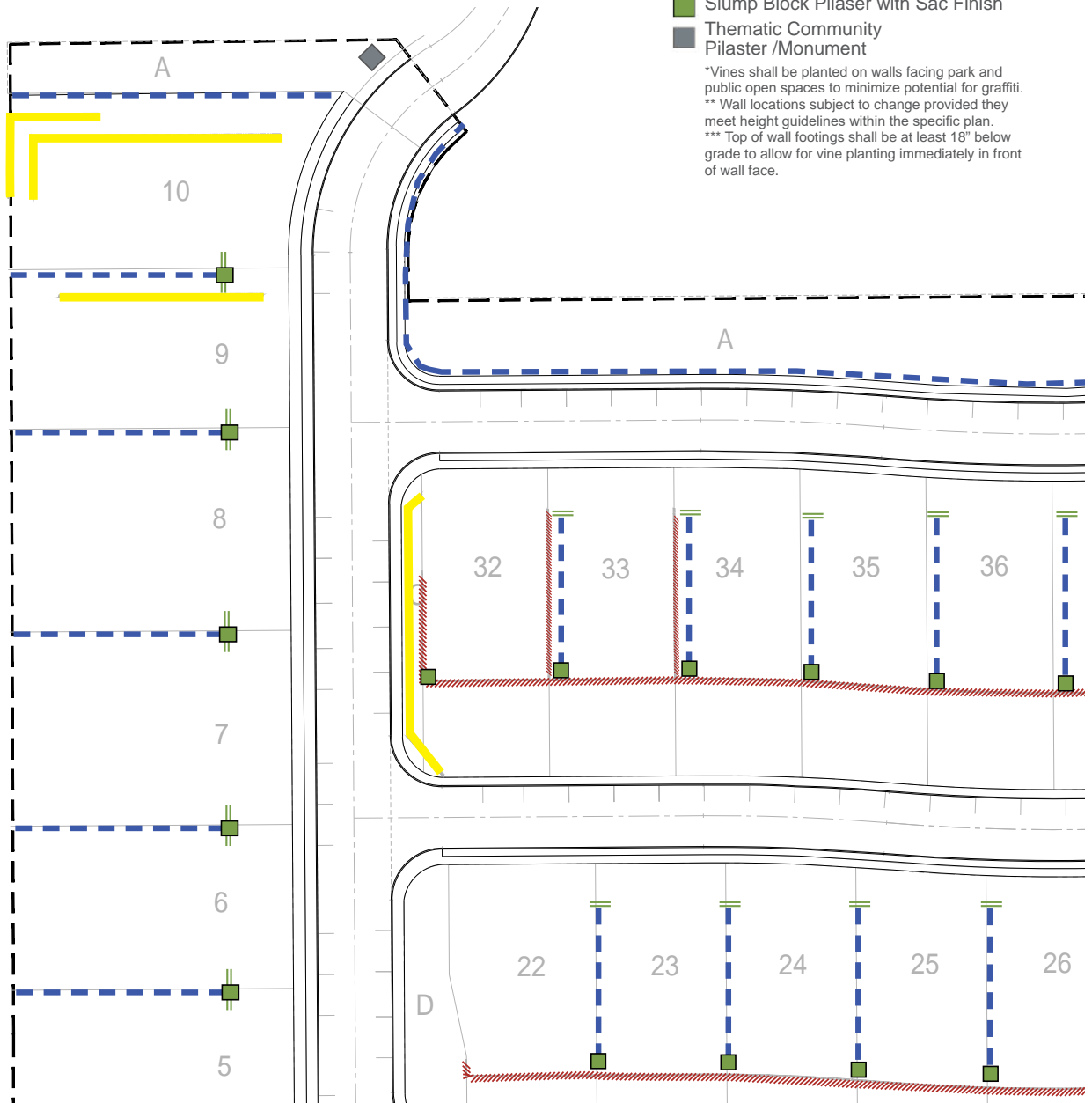



# Wall & Fence Plan Enlargements

- - - - Slump Block
- Slump Block with Sac Finish
- - - - Top of Slope View Fence
- Retaining Wall (Height Varies)
- Slump Block Pilaster with Sac Finish
- Thematic Community Pilaster /Monument

\*Vines shall be planted on walls facing park and public open spaces to minimize potential for graffiti.  
 \*\* Wall locations subject to change provided they meet height guidelines within the specific plan.  
 \*\*\* Top of wall footings shall be at least 18" below grade to allow for vine planting immediately in front of wall face.

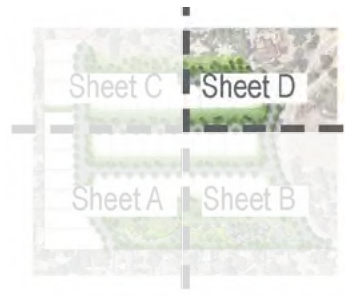
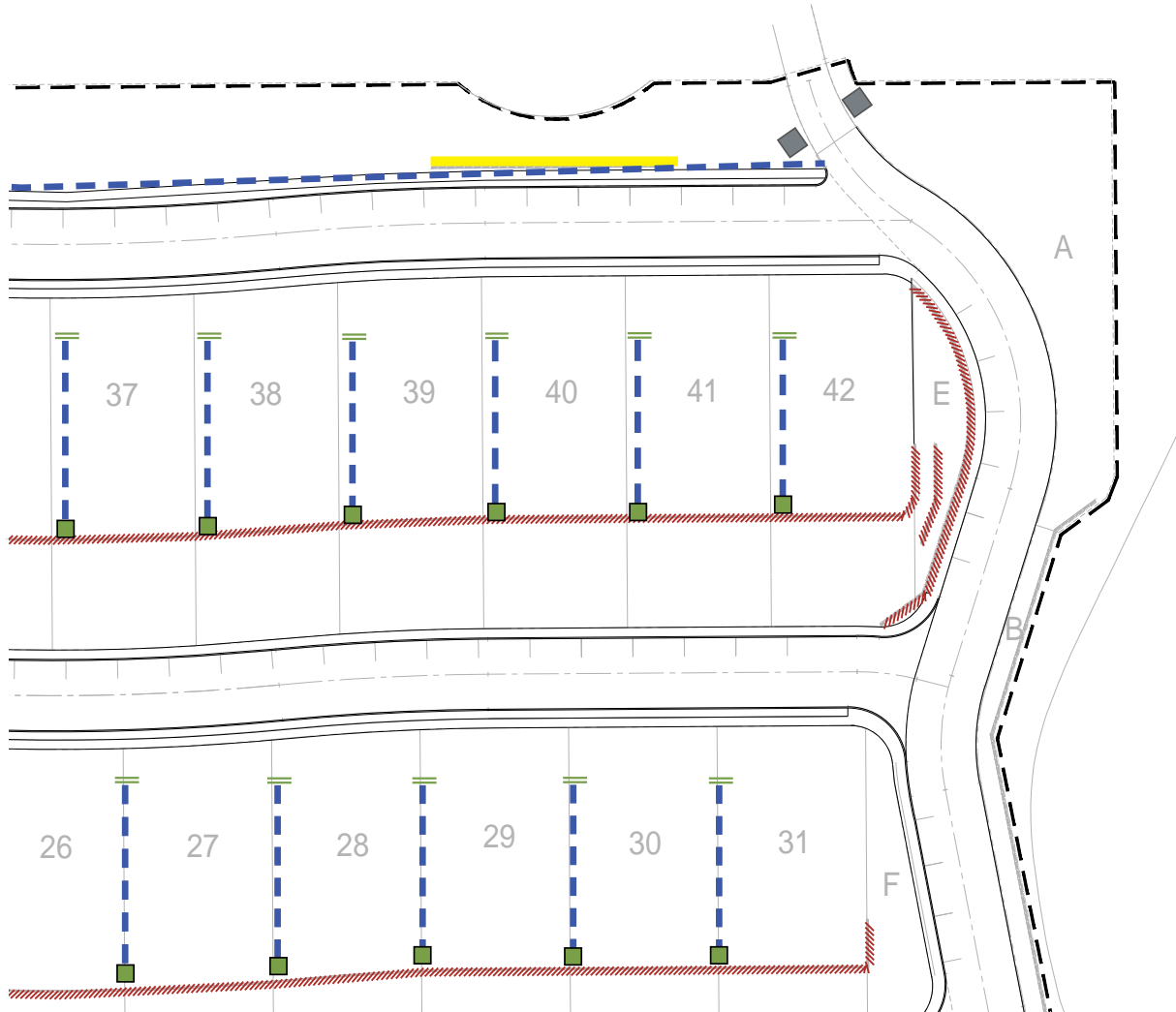

# Appendix 3B

Offsite Improvement Plan

# The Meadows at Bailey Canyon

## Carter Sidewalk - Options 1 and 2

### Offsite Improvement Plan

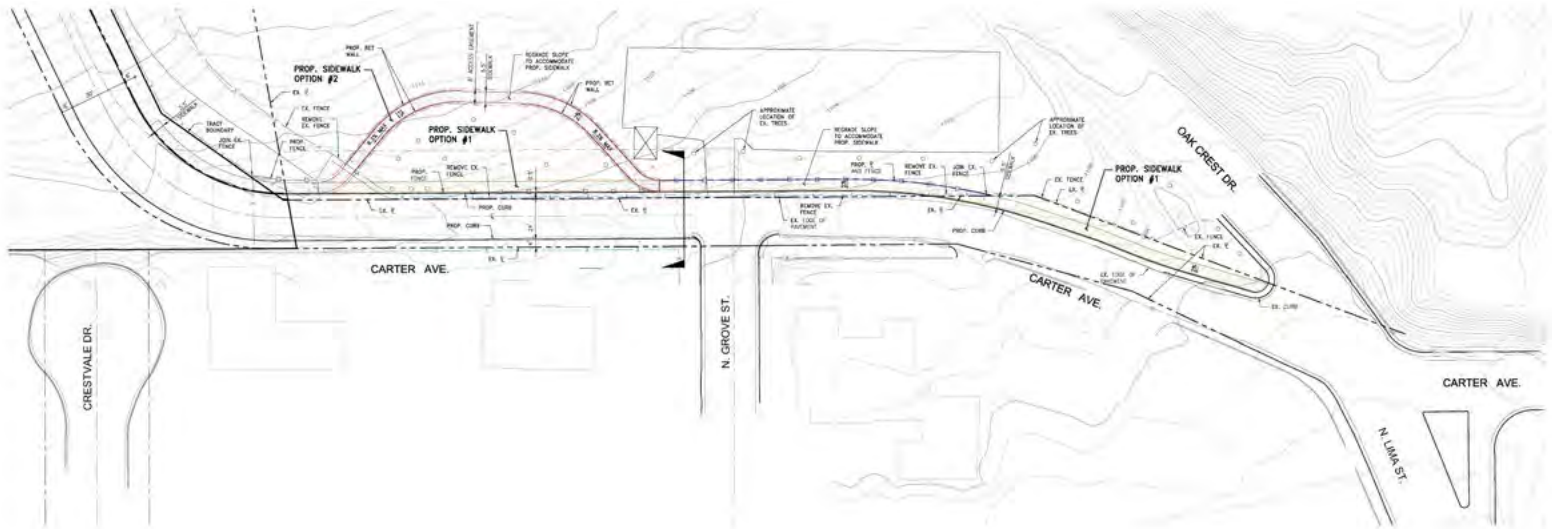

- NOTE:**
- 1) EXISTING TREES ARE GRAPHICAL, TO BE CONFIRMED WITH SURVEY.
  - 2) EXISTING SLOPE ON NORTH SIDE OF CARTER TO BE REALIGNED TO ACCOMMODATE PROPOSED SIDEWALK. REGRADING COULD IMPACT EXISTING TREES.





# The Meadows at Bailey Canyon

## Bailey Canyon Park Access Exhibit

### Offsite Improvement Plan

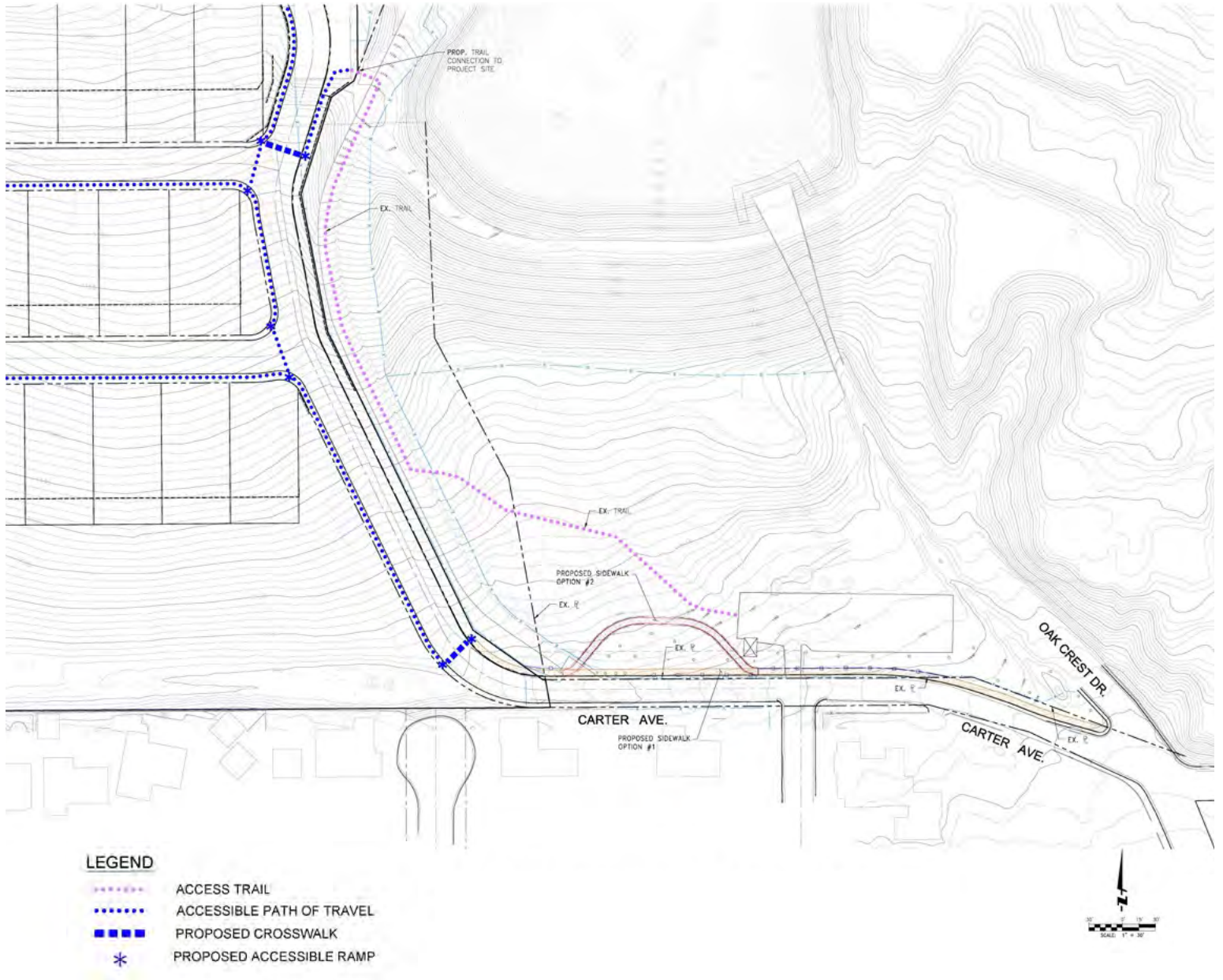

# Appendix 3C

Conceptual Park Buffer Sections



**SECTION A:**  
 500 SUNNYSIDE AVE.  
 SIERRA MADRE, CA 91024



**SECTION B:**  
 523 SIERRA KEYS DR.  
 SIERRA MADRE, CA 91024



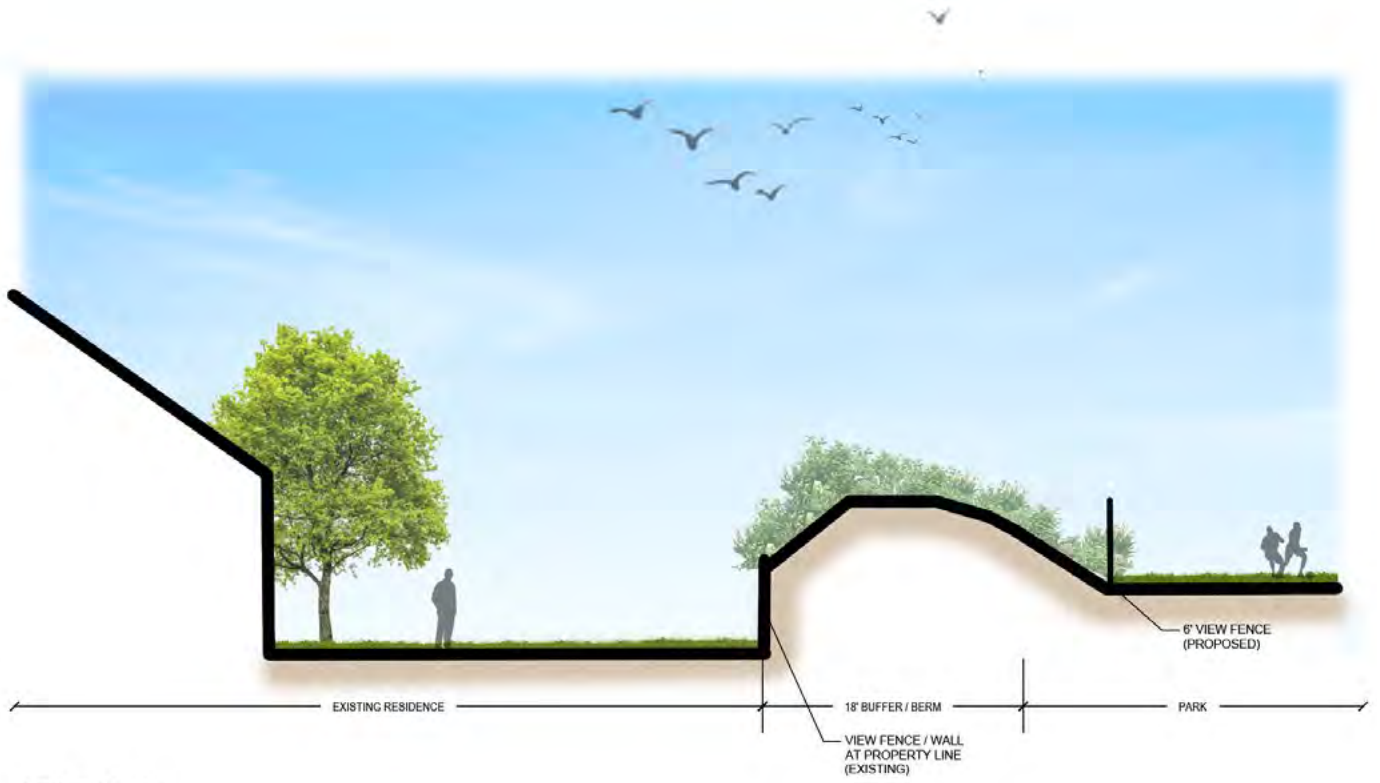

**SECTION C:**  
 513 SIERRA KEYS DR.  
 SIERRA MADRE, CA 91024

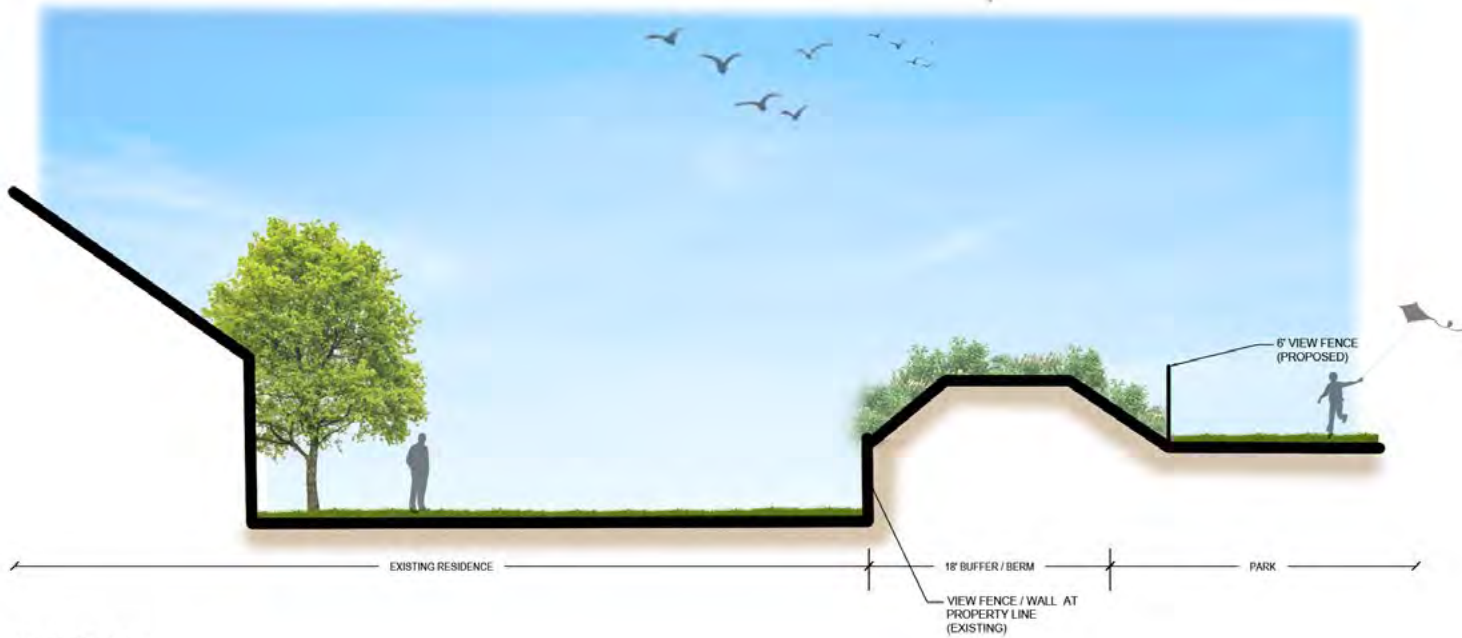

**SECTION D:**  
 507 SIERRA KEYS DR.  
 SIERRA MADRE, CA 91024

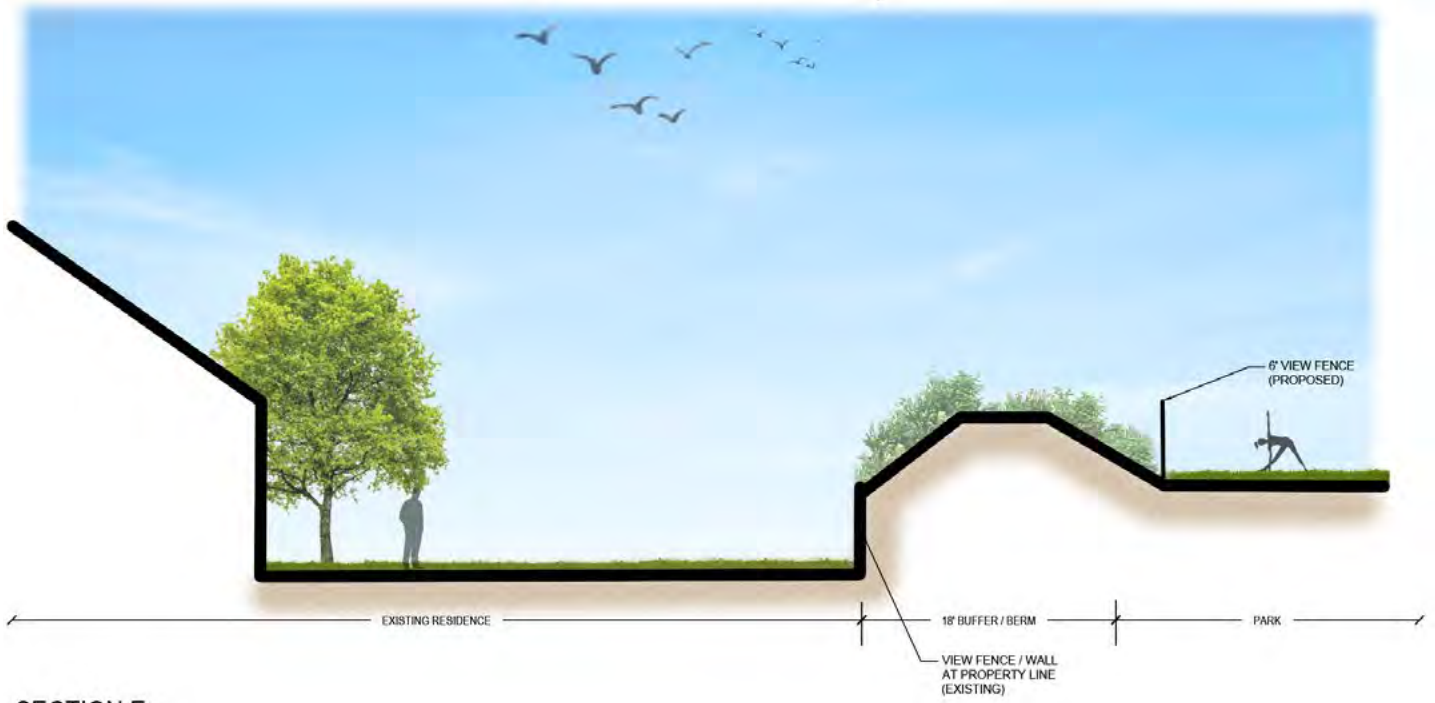

**SECTION E:**  
 501 SIERRA KEYS DR.  
 SIERRA MADRE, CA 91024



**SECTION F:**  
 496 SIERRA KEYS DR.  
 SIERRA MADRE, CA 91024



**SECTION G:**  
 501 CRESTVALE DR.  
 SIERRA MADRE, CA 91024





# Appendix 4A

Fuel Modification by Zone

### **Plant Selection Guidelines by Zone**

Fuel Modification plant selection and location should focus on the density and arrangement of plants related to structures. Second, choose zone appropriate species based on plant characteristics such as moisture content, resin/pitch and the production of dead litter from leaves, bark, seed pods etc. The following guidelines are intended to simplify this process through zone specific compositions.

Zone A (30' from any qualifying structure or the property line whichever is first)

- Zone A should be planted “lean” and selections should consist of small herbaceous or succulent plants less than 2'-3' in height or regularly irrigated and mowed lawns.
- It is best not to use woody trees, shrubs and perennial species or masses of un-mowed grasses within 10 feet of the structure.
- Occasional accents of woody plants can be used sparingly to soften hard edges of structures if the selections are widely spaced and zone appropriate.
- Consider locating hardscape features such as walkways, patios, driveways, sport courts etc. adjacent to the structure itself. Potted plants can be used to soften walls if necessary.

Zone B (30'-100' from any qualifying structure)

- Zone B can be planted with a slightly higher density than Zone A. However, care should be taken not to create horizontal or vertical fuel ladders (see basic fire behavior graphics).
- Screen plantings can be used to hide unsightly views. Hedging is discouraged as it promotes the accumulation of dead litter inside the live hedge.
- Zone B is the ideal location to introduce larger shade trees provided they are zone appropriate and the canopies are not continuous.
- Avoid planting woody plant species larger than 3' at maturity directly beneath any tree canopy.

Zone C (100'-200' from any qualifying structure)

- Zone C often is not landscaped on many projects but is still subject to hazard reduction requirements (brush clearance). Do not denude the property.  
<http://www.readyforwildfire.org/>
- If Zone C is to be landscaped, avoid increasing plant density beyond guidelines for Zone B.

Adjacent to Access Roads

- Maintain Fire Access roads with a 20' wide path that remains clear to the sky.

Fuel Ladders/Basic Fire Behavior

Before selecting and locating plants on a Fuel Modification plan a basic understanding of wildland fire behavior is the key factor in properly arranging plants. Eliminating and avoiding the creation of fuel ladders should be the chief concern. Understanding that anything planted in the landscape can become receptive fuel for wildfire: the way it is arranged and maintained will greatly influence fire intensity. The following diagrams will aide in arranging plant compositions wisely.

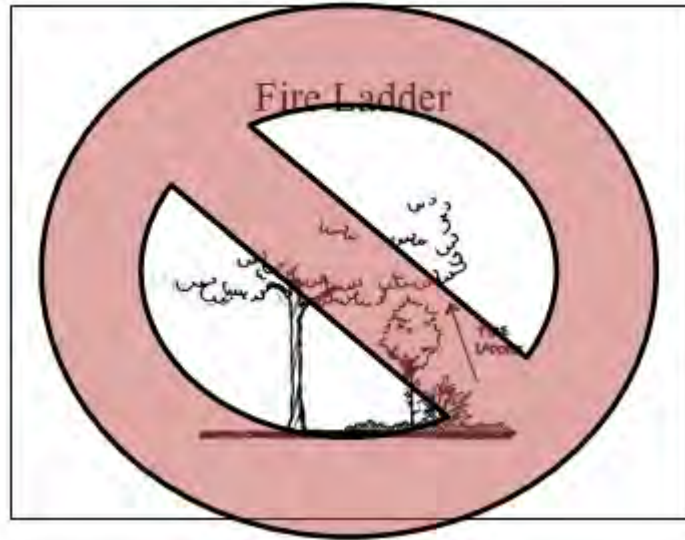

Figure 1: Fire Ladders or Fuel Ladders should be eliminated. The diagram above illustrates what not to do.



Figure 2: Eliminate the vertical and horizontal continuity. This is a good example of adequate separation.

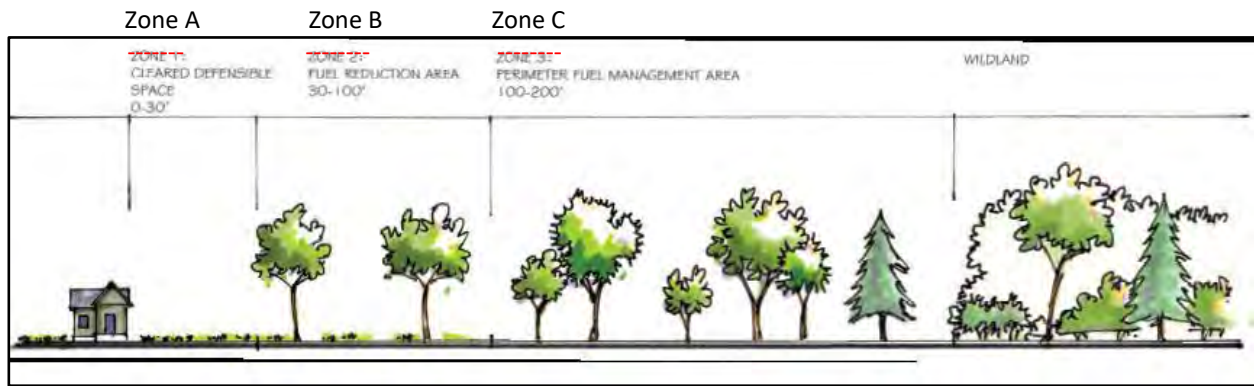

Figure 3: Note the progressive increase in density and arrangement moving away from the structure.

#### Plant Placement Do's

- Do: use “mass plantings” or herbaceous/succulents as ground covers even if they are not traditionally used as such. Mass plantings if properly selected, can eliminate fuel ladders.
- Do: plant using spacing resulting in near complete coverage at maturity.
- Do: consider using patio trees as an informal screen in Zone A.
- Do: consider vines as an alternative to hedges on walls or fences 10' from structures.
- Do: select varieties of plants that are slower growing and reach manageable sizes at maturity.
- Do: use plants that are appropriately scaled to the size of the property and structure. A single story house does not need to be shaded by a 100' tall Sweetgum.

#### Plant Placement Don'ts

- Don't plant hedges directly against structures. This includes espaliers of large shrubs not allowed in Zone A, or hedges taller than 6 feet or within 10' of the structure.
- Don't plant large shrubs and trees in continuous lines or large masses in Zones A or B.
- Don't plant at densities that result in an “instant landscape.”
- Don't plant large species and use pruning to reduce overall size.
- Don't plant vines on structures. Vines become receptive fuel beds for embers (fire brands).
- Don't assume any plant is “fire proof.” All plants will burn and assuming a plant is ignition resistant can be very misleading.
- Don't use large woody species in mass plantings.



### Undesirable Plants/Target Species

Plants listed below are not allowed as part of an approved Fuel Modification Plan. In addition to this list, designers should avoid planting known invasive plants such as Pampas grass and Hottentot Fig. If there are questions, please reference the California Invasive Plant Council.

<http://www.cal-ipc.org/>

\*This list is not inclusive and some cultivars (dwarf etc.) within the genus listed may be acceptable.

*Adenostoma fasciculatum* – Chamise

*Adenostoma sparsifolium* – Red Shank

*Artemisia californica* – California Sagebrush

*Eriogonum fasciculatum* – Common Buckwheat

*Cortaderia* spp. – Pampas Grass

*Cupressus* spp. – Cypress

*Eucalyptus* spp – Eucalyptus

*Jasminum humile* – Italian Jasmine

*Plumbago auriculata* – Cape Plumbago

*Tecoma capensis* – Cape Honeysuckle

# Appendix 4B

CalFire Defensible Space and Hardening

**WILDFIRE IS COMING.  
ARE YOU...**

**READY?**

**DEFENSIBLE SPACE AND  
HARDENING YOUR HOME.**



**THOUSANDS OF WILDFIRES STRIKE CALIFORNIA  
EVERY YEAR. IT'S NOT A MATTER OF IF YOUR  
HOME IS AT RISK, BUT WHEN.**

**ReadyForWildfire.org**

# PLANT AND TREE SPACING

The spacing between grass, shrubs, and trees is crucial to reduce the spread of wildfire. The spacing needed is determined by the type and size of the shrubs and trees, as well as the slope of the land. For example, a property on a steep slope with larger plant life will require greater spacing between trees and shrubs than a level property that has small, sparse vegetation.

## VERTICAL SPACING

**Remove all tree branches at least 6 feet from the ground.**

If shrubs are under trees, additional vertical space is needed. Lack of vertical space can allow a fire to move from the ground to the shrubs to the treetops like a ladder.



## FIRE-SAFE LANDSCAPING

Fire-safe landscaping isn't necessarily the same thing as a well-maintained yard. Fire-safe landscaping uses fire-resistant plants that are strategically planted to resist the spread of fire to your home.

The good news is that you don't need to spend a lot of money to make your landscape fire-safe. And fire-safe landscaping can increase your property value and conserve water while beautifying your home. For more information on fire-safe landscaping, visit: [ReadyForWildfire.org/landscaping](https://www.readyforwildfire.org/landscaping).

## MINIMUM VERTICAL SPACING BETWEEN TREES AND SHRUBS

To determine the proper vertical space between shrubs and the lowest branches of trees, use the formula below.

### Example:

A five-foot shrub is growing near a tree.

$3 \times 5 = 15$  feet of clearance needed between the top of the shrub and the lowest tree branches.

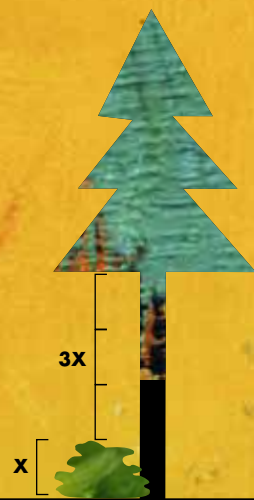



## MINIMUM HORIZONTAL SPACING FOR TREES AND SHRUBS

Horizontal spacing depends on the slope of the land and the height of the shrubs or trees. Check the diagrams below to determine spacing distance.



# DEFENSIBLE SPACE

Creating and maintaining defensible space is essential for increasing your home's chance of surviving a wildfire. It's the buffer that homeowners are required to create on their property between a structure and the plants, brush and trees or other items surrounding the structure that could catch fire. This space is needed to slow the spread of wildfire and improves the safety of firefighters defending your home.

**Two zones make up the required 100 feet of defensible space:**

## **ZONE 1—Extends 30 feet out from buildings, decks, and other structures**

- 1 Remove all dead plants, grass and weeds.
- 2 Remove dead or dry leaves and pine needles from your yard, roof and rain gutters.
- 3 Trim trees regularly to keep branches a minimum of 10 feet from other trees.
- 4 Remove dead branches that hang over your roof. And keep branches 10 feet away from your chimney.
- 5 Relocate exposed woodpiles outside of Zone 1 unless they are completely covered in a fire resistant material.
- 6 Remove or prune flammable plants and shrubs near windows.
- 7 Remove vegetation and items that could catch fire from around and under decks.
- 8 Create a separation between trees, shrubs and items that could catch fire, such as patio furniture, swing sets, etc.

## **IMMEDIATE ZONE—0 to 5 feet from buildings and other structures**

No Vegetation

## **ZONE 2—Extends 30 to 100 feet from buildings and other structures**

- 9 Cut or mow annual grass down to a maximum height of 4 inches.
- 10 Create horizontal spacing between shrubs and trees. (See diagram)
- 11 Create vertical spacing between grass, shrubs and trees. (See diagram)
- 12 Remove fallen leaves, needles, twigs, bark, cones, and small branches. However, they may be permitted to a depth of 4 inches if erosion control is an issue.

## **BOTH ZONES—0 to 100 feet from buildings and other structures**

- 13 Mow before 10 a.m., but never when it's windy or excessively dry.
- 14 Protect water quality. Do not clear vegetation near waterways to bare soil. Vegetation removal can cause soil erosion—especially on steep slopes.

## ARE YOU DOING THE RIGHT THING—THE WRONG WAY?

Each year, CAL FIRE responds to hundreds of fires started by Californians using equipment the wrong way. If you live in a wildland area, all equipment must be used with extreme caution.

Lawn mowers, metal-bladed trimmers, chain saws, grinders, welders, and tractors can all start a wildland fire if not used properly. Do your part to keep your community fire-safe.

### **HERE'S HOW TO DO IT THE RIGHT WAY:**

#### **Mowing**

Metal blades striking rocks can create sparks and start fires in dry grass. Use caution.

#### **Spark Arresters**

In wildland areas, spark arresters are required on all

portable, gasoline-powered equipment. This includes tractors, harvesters, chainsaws, weed-trimmers and mowers.

- Keep the exhaust system, spark arresters and mower in proper working order and free of carbon buildup.
- Use the recommended grade of fuel, and don't top it off.

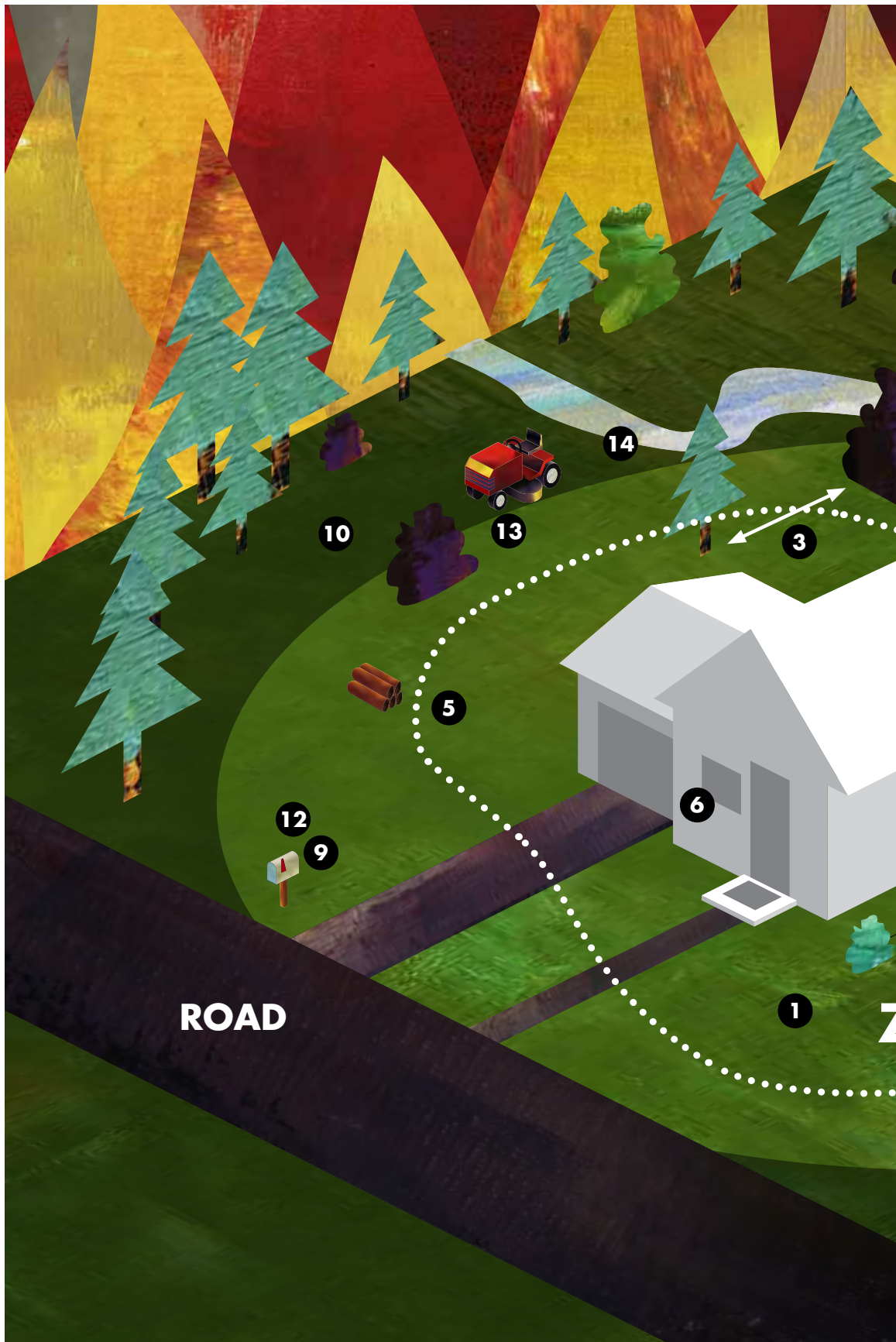



# KNOW THE LAW BE FIRE SMART

100 FEET OF DEFENSIBLE SPACE IS REQUIRED UNDER THE PUBLIC RESOURCES CODE (PRC) 4291. CALIFORNIA BUILDING CODE CHAPTER 7A REQUIRES CERTAIN CONSTRUCTION MATERIALS AND METHODS FOR HOMES IN WILDLAND AREAS. BE SURE TO CONTACT YOUR LOCAL FIRE DEPARTMENT FOR ADDITIONAL REQUIREMENTS TO ENSURE YOUR HOME IS COMPLIANT WITH THE LAW. [READYFORWILDFIRE.ORG/THELAW](http://READYFORWILDFIRE.ORG/THELAW)

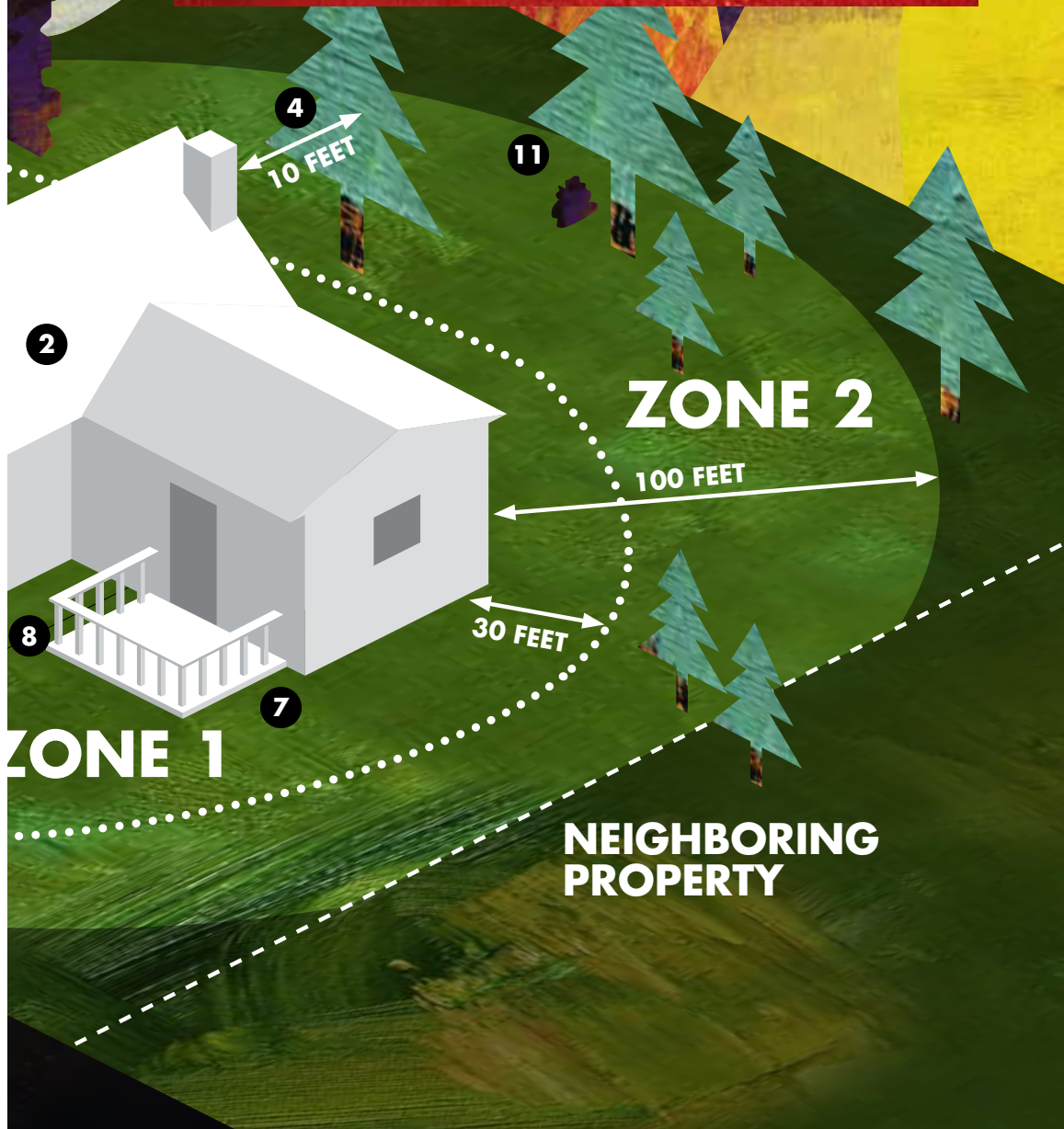



## IMMEDIATE (NONCOMBUSTIBLE) ZONE

Why is it important to create and maintain 5 feet of noncombustible space around the exterior of a building?

Wildfire risks are on the rise, but there are ways home and business owners can take control of their vulnerabilities. Changes made to a structure and its surroundings within 100 feet can make a big impact. Research from the Insurance Institute for Business and Home Safety (IBHS) shows that the first 0 to 5 feet around the structure, known as the immediate zone or noncombustible zone, has the greatest impact on your risk. IBHS and the National Fire Protection Association® (NFPA®) recommend keeping this zone well-maintained and clear of combustible materials.

### IBHS Research

The main objective of the 0-to-5-foot zone is to reduce the potential that embers landing near a building will ignite fuels and expose the area around a home to a direct flame (Figure 1). Removing anything that can ignite from embers is critically important. To verify how effective a 5-foot noncombustible zone is around a building, more than 180 tests were conducted in 2018 at the IBHS Research Center to evaluate fire behavior and heating of buildings (Figures 2a & 2b).

### Key Observations

- For combustible landscaping, such as wood mulch, the thickness of the mulch bed, wind speed, and location of the flame and building all impact the potential of mulch to ignite and how quickly fire can spread to the building.
- Burning mulch generates embers that can ignite nearby mulch, increasing the chances of direct flame contact spreading to the building.
- When flames are 5 feet away, a building's surface temperature is below temperatures that could cause ignition. However, corners of a building (45-degree angles) experience a higher temperature when exposed to flames, even when a 5-foot space is present. Testing showed that corners can be more vulnerable due to fire spread through fuel (such as mulch) on the ground, because at the same wind speed, wind blowing directly at a wall (90-degree angle) will result in taller flames and more radiant heat, while wind on a corner (45-degree angle) will result in longer flames that are closer to the ground.

### Recommendations

- Keep the corner areas of a building clear of combustible materials due to the higher probability of having direct flame touching the surrounding ground.
- Keep gutters free of debris and use metal gutters.
- Install hard surfaces, such as a concrete walkway, or use noncombustible mulch products, such as rock.
- Keep the lawn well irrigated and use low-growing herbaceous (non-woody) plants. Shrubs and trees are not recommended in the 5-foot zone.
- Remove dead vegetation and implement a maintenance strategy to keep the 5-foot zone clear of dead plant materials.
- Mitigating home ignition zones shouldn't stop at 5 feet from the building. It should be combined with the footprint of an attached deck and area that extends away from the building up to 100 feet or to the property line.



**Figure 1** – Creating and maintaining home ignition zones (defensible space) around your property are proven ways to reduce risks of property damage during a wildfire, as tests at the IBHS Research Center have shown.



**Figure 2a** Experiments conducted at the IBHS Research Center to study the effectiveness of creating a noncombustible space around buildings.



**Figure 2b** Embers impacting a building; left side with combustible (wood) and the right with noncombustible (rock) mulch.

© Insurance Institute for Business & Home Safety

### Learn More

- ▶ For online training and other resources, see [nfpa.org/firewise](https://nfpa.org/firewise).
- ▶ Access the latest research from IBHS at [ibhs.org](https://ibhs.org).



**FIREWISE USA®**  
RESIDENTS REDUCING WILDFIRE RISKS

This publication was produced in cooperation with the USDA Forest Service, US Department of the Interior and the National Association of State Foresters. NFPA is an equal opportunity provider. Firewise® and Firewise USA® are registered trademarks of the National Fire Protection Association, Quincy, MA. Firewise USA® is a program of the National Fire Protection Association.

# HARDENING YOUR HOME

**FLYING EMBERS CAN DESTROY HOMES UP TO A MILE AHEAD OF A WILDFIRE. PREPARE (HARDEN) YOUR HOME NOW BEFORE FIRE STARTS.**

## **SOME THINGS YOU CAN DO TO HARDEN YOUR HOME:**

**Roof:** Your roof is the most vulnerable part of your home. Homes with wood or shingle roofs are at high risk of being destroyed during a wildfire.

Build your roof or re-roof with materials such as composition, metal or tile. Block any spaces to prevent embers from entering and starting a fire.

**Vents:** Vents on homes create openings for flying embers.

- Protect vents in eaves or cornices with baffles to block embers. (Mesh is not enough.)

### **Eaves and Soffits:**

Eaves and soffits should be protected with ignition-resistant or non-combustible materials.

**Windows:** Heat from a wildfire can cause windows to break even before the home ignites. This allows burning embers to enter and start fires inside. Single-paned and large windows are particularly at risk.

- Install dual-paned windows with one pane of tempered glass.
- Consider limiting the size and number of windows that face large areas of vegetation.

**Decks:** Surfaces within 10 feet of the building should be built with ignition-resistant, non-combustible, or other approved materials.

- Remove all combustible items from underneath your deck.

**Exterior Walls:** Wood products such as boards, panels or shingles are common siding materials. However, they are combustible and not good choices for fire-prone areas.

- Build or remodel your walls with ignition-resistant building materials, such as stucco, fiber or cement siding, fire-retardant-treated wood, or other approved materials.
- Be sure to extend materials from the foundation to the roof.

**Rain Gutters:** Screen or enclose rain gutters to prevent accumulation of plant debris.

**Patio Cover:** Use the same ignition-resistant materials for patio covers as a roof.

**Fences:** Consider using ignition-resistant or non-combustible fence materials to protect your home during a wildfire.

## **Additional Home Fire Safety Steps:**

Go to [ReadyForWildfire.org/hardening](https://ReadyForWildfire.org/hardening) for more important information on the following:

- Driveways and Access Road Information
- Address Visibility
- Equipment Use Safety
- Garage Safety
- Water Supply Access
- Ignition-Resistant Materials

# READY, SET, GO! PREPARATION GUIDES

Preparing for a wildfire starts with three simple steps: **Ready, Set, Go!** Keep all three wildfire preparation guides on hand as a quick reference for helping your family and property be safe in the event of a wildfire.

## WILDFIRE IS COMING PREPARATION GUIDES:



### Step 1: Is Your Home Ready?

Creating defensible space and hardening your home against wildfire.



### Step 2: Are You Set?

Developing a Wildfire Action Plan.



### Step 3: Are You Ready to Go?

A quick-reference evacuation guide.



Go to **ReadyForWildfire.org** for more detailed information on all three guides to prepare for and survive a wildfire.

# Appendix 5A

Architectural Styles Reference Guide



# 1 Craftsman Style

The Craftsman Style evolved from previously popular Prairie style architecture, traditional Oriental wooden architecture, and the Arts and Crafts Movement. The typical vernacular Craftsman bungalow was heavily influenced by the works of Charles Sumner Greene and Henry Mather Greene of Southern California. Character defining features for the Craftsman style include the following.

- a. Exterior finishes
  - i. Shingle or horizontal siding that meet fire code.
  - ii. Exterior plaster or stucco
  - iii. Masonry cladding accents
  - iv. Stone or brick accents at base of elevations



- b. Roofs
  - i. Low-pitched, gabled (sometimes hipped) roof
  - ii. Wide eave overhang that meets fire code.
  - iii. Exposed rafters
  - iv. Shed, gabled, or eyebrow dormers
  - v. Decorative false beams or braces under gables
  - vi. Multiple roof planes

c. Porches and balconies

- i. Full or partial-width porches
- ii. Gabled or shed roof over porch
- iii. Square or tapered wood supports at porches

d. Windows and doors

- i. Wide windows and door casings
- ii. Recessed, wood frames
- iii. Fixed or double-hung windows



e. Architectural details

- i. Rectangular massing that is one or two stories in height
- ii. A defined base element
- iii. Triangular knee brace supports



## 2 Spanish Colonial Revival

The Spanish Colonial Revival style has a rich history and popularity in Southern California with a basis in the heavy influence of Spanish and Moorish architectural styles. During the Spanish colonial period in the late 1400s the architectural traditions known as the Hispano Moorish style were brought to the Americas. The convergence of religious and architectural traditions during the Spanish Colonial period set the stage for the Spanish Colonial Revival architectural movement that gained great popularity in the 1920s and 1930s in Southern California. The most significant character-defining features of the Spanish Colonial Revival style include the following.

- a. Exterior finishes
  - i. Smooth stucco in natural colors, typically white or tan
  - ii. Walls extend into gable roof without a break
  - iii. Arched entryways or deep recess



- b. Roofs
  - i. Low pitched side or cross-gabled roof, occasionally a hipped or flat roof section
  - ii. Multi-level roof
  - iii. Minimal eaves with little to no overhang
  - iv. Red clay tiles either Spanish (S-shaped) or Mission (half-cylinder)

c. Porches and balconies

- i. Porches are uncommon or recessed behind an open arcade
- ii. Roofed or open balconies are common
- iii. Wrought-iron balconies

d. Windows and doors

- i. Rounded arches above doors and windows
- ii. Recessed doors and windows
- iii. One large focal window is common
- iv. Fenestration irregularly placed and recessed
- v. Carved wood entry doors



e. Architectural details

- i. Simple rectangular or L-shaped massing, typically one to two-stories in height with round, square, or polygonal towers
- ii. Asymmetrical façades
- iii. Stucco sided chimneys
- iv. Decorative tiles
- v. Outdoor spaces, such as courtyards with or without covered arcaded walk-ways



### 3 Contemporary Farmhouse

The City of Sierra Madre began with an agricultural history, similar to most of this region. This is exemplified by the historic Carter Barn and adjacent Macomber Cabin, which were built in a practical and classic farmhouse style. The informality of this style lends itself to contemporary family living with many indoor-outdoor possibilities.

The most significant character defining features of the Contemporary Farmhouse style include the following:

- a. Exterior finishes
  - i. Vertical “board and batten” siding or horizontal lap siding
  - ii. Masonry accents
  - iii. Stucco



- b. Roofs
  - i. Medium to steeper pitch roofs with gable features, may also include pitch breaks with a steeper pitch ending in a shallower one
  - ii. Shed or gabled dormer windows
  - iii. Small eave overhangs
  - iv. Gable end decorative details

c. Porches and balconies

- i. Wide porches with, or without, bracketed posts are common
- ii. Roofed or open balconies are possible in this informal style
- iii. Porches and balconies have simple wood railings
- iv. Porches sometimes have contrasting metal roofing

d. Windows and doors

- i. Windows are single or double hung with divided lites
- ii. Front doors are sometimes partially glazed or have side-lites
- iii. Shutters in a rustic style are common



e. Architectural details

- i. Asymmetrical facades
- ii. Brackets or knee braces support small awning roofs or enhance posts
- iii. Simple massing
- iv. Possible small rectangular cupolas or weathervanes as decorative elements



## 4 Modern

While the Modern style was not born here, it has come to flourish in Southern California. The mild local climate provides many opportunities for the indoor-outdoor connection and openness that is inherent in this style.

While freedom from material and formal constraints characterize modern architecture, in the residential realm, the most significant character defining features of the Modern style include, but are not limited to, the following:

- a. Exterior finishes
  - i. Stucco
  - ii. Siding or slats as accents
  - iii. Masonry accents
  - iv. Metal accents



- b. Roofs
  - i. Shallow pitch shed roofs
  - ii. Combination of flat and sloping roofs
  - iii. Shallow pitch hip roofs
  - iv. Asymmetrical gables
- c. Windows and doors
  - i. Large, windows without divided lites
  - ii. Corner windows
  - iii. Slab style doors in various finishes or colors, with or without side lites

d. Porches and balconies

- i. Porches are not common in this style but are not prohibited
- ii. Balconies, either open or roofed
- iii. Metal, cable or glass railings at balconies



e. Architectural details

- i. Cantilevered eyebrow shades
- ii. Wall planes extending beyond building massing
- iii. Simple, unornamented lighting fixtures
- iv. Asymmetrical massing and fenestration



# Appendix 5B

## Architectural Elevations

# THE MEADOWS AT BAILEY CANYON

## MODERN

1-Story  
Single Family Home

2,700-2,800 SF Home Size  
8,000-10,000 SF Lot Size

4 Bed / 3.5 Bath

2-Car Garage



FRONT ELEVATION



REAR ELEVATION

Renderings are artist conception based on preliminary information, not to scale and subject to change.

# THE MEADOWS AT BAILEY CANYON

## MODERN

1-Story  
Single Family Home

2,700-2,800 SF Home Size  
8,000-10,000 SF Lot Size

4 Bed / 3.5 Bath

2-Car Garage



RIGHT ELEVATION



LEFT ELEVATION

Renderings are artist conception based on preliminary information, not to scale and subject to change.



# THE MEADOWS AT BAILEY CANYON

## CONTEMPORARY SPANISH

1-Story  
Single Family Home

2,700-2,800 SF Home Size  
8,000-10,000 SF Lot Size

4 Bed / 3.5 Bath

2-Car Garage



FRONT ELEVATION



REAR ELEVATION

Renderings are artist conception based on preliminary information, not to scale and subject to change.

# THE MEADOWS AT BAILEY CANYON

## CONTEMPORARY SPANISH

1-Story  
Single Family Home

2,700-2,800 SF Home Size  
8,000-10,000 SF Lot Size

4 Bed / 3.5 Bath

2-Car Garage



RIGHT ELEVATION



LEFT ELEVATION

Renderings are artist conception based on preliminary information, not to scale and subject to change.



# THE MEADOWS AT BAILEY CANYON

## MODERN

2-Story  
Single Family Home

3,000-3,100 SF Home Size  
8,000-10,000 SF Lot Size

5 Bed / 5.5 Bath

3-Car Garage



FRONT ELEVATION



REAR ELEVATION

Renderings are artist conception based on preliminary information, not to scale and subject to change.



# THE MEADOWS AT BAILEY CANYON

## MODERN

2-Story  
Single Family Home

3,000-3,100 SF Home Size  
8,000-10,000 SF Lot Size

5 Bed / 5.5 Bath

3-Car Garage



RIGHT ELEVATION



LEFT ELEVATION

Renderings are artist conception based on preliminary information, not to scale and subject to change.

# THE MEADOWS AT BAILEY CANYON

## PLAN 2 - CONTEMPORARY CRAFTSMAN

2-Story  
Single Family Home

3,000-3,100 SF Home Size  
8,000-10,000 SF Lot Size

5 Bed / 5.5 Bath

3-Car Garage



FRONT ELEVATION



REAR ELEVATION

Renderings are artist conception based on preliminary information, not to scale and subject to change.



# THE MEADOWS AT BAILEY CANYON

## PLAN 2 - CONTEMPORARY CRAFTSMAN

2-Story  
Single Family Home

3,000-3,100 SF Home Size  
8,000-10,000 SF Lot Size

5 Bed / 5.5 Bath

3-Car Garage



RIGHT ELEVATION



LEFT ELEVATION

Renderings are artist conception based on preliminary information, not to scale and subject to change.



# THE MEADOWS AT BAILEY CANYON

## CONTEMPORARY FARMHOUSE

2-Story  
Single Family Home

3,100-3,200 SF Home Size  
8,000-10,000 SF Lot Size

5 Bed / 4.5 Bath

3-Car Garage



FRONT ELEVATION



REAR ELEVATION

Renderings are artist conception based on preliminary information, not to scale and subject to change.

# THE MEADOWS AT BAILEY CANYON

## CONTEMPORARY FARMHOUSE

2-Story  
Single Family Home

3,100-3,200 SF Home Size  
8,000-10,000 SF Lot Size

5 Bed / 4.5 Bath

3-Car Garage



RIGHT ELEVATION



LEFT ELEVATION

Renderings are artist conception based on preliminary information, not to scale and subject to change.